



Kabelkanalen - Cable ducts

aluminium

D

Crafty MF H100/H150

Gouda Holland



GoudaHolland

Notities

Notes

Crafty MF

Handwriting practice area with horizontal dotted lines.

Kabelkanalen Cable ducts



Crafty MF H100/H150

kabelladder

aluminium

cable ladder

aluminium

Crafty MF



Crafty MF H100/H150

Kabelladder, Aluminium

Cable ladder, Aluminium

- chemisch resistent
 - aluminium kwaliteit AW-5754-H22
 - afsluitbaar d.m.v. deksels
 - standaardlengte 3000 mm
 - bevestigingsmateriaal A4 (ISO 3506)
- Op verzoek:
- bodemprofielen h.o.h. 150 mm
 - afwijkende breedte-, hoogte- en diktematen
 - hulpstukken > R = 300

- *chemically resistant*
 - *aluminium quality AW-5754-H22*
 - *a wide range of covers available*
 - *standard length 3000 mm*
 - *fastening products A4 (ISO 3506)*
- On request:*
- *rung distance c.t.c. 150 mm*
 - *deviant width, heights and thickness*
 - *fittings > R = 300*

Crafty MF H100

Bodemprofielen h.o.h. 300 mm
Rung distance c.t.c. 300 mm

- materiaaldikte zijwand 2,5 mm
 - materiaaldikte bodemprofiel 2 mm
 - hulpstukken R = 300-600
- *material thickness sidewall 2.5 mm*
• *material thickness rung 2 mm*
• *fittings R = 300-600*

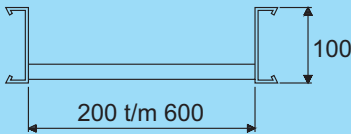

overspanning tot max. 3 meter
max. span: 3 mtr.

Crafty MF H150

Bodemprofielen h.o.h. 300 mm
Rung distance c.t.c. 300 mm

- materiaaldikte zijwand 2,5 mm
 - materiaaldikte bodemprofiel 2 mm
 - hulpstukken R = 300-600
- *material thickness sidewall 2.5 mm*
• *material thickness rung 2 mm*
• *fittings R = 300-600*

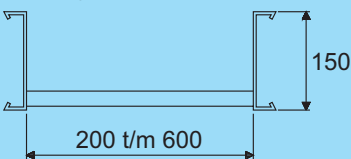

overspanning tot max. 4,5 meter
max. span: 4.5 mtr.

Kabelkanalen Crafty MF

Cable ducts Crafty MF

Kabelladder, Aluminium

Cable ladder, Aluminium

D2-1 Algemeen

- Inhoudsopgave
- Toepassingen
- Technische gegevens
- Belastbaarheidstabellen
- Systemoverzicht

Pag.

D2-1-2
D2-1-3
D2-1-4
D2-1-5
D2-1-6

D2-1 General

- Table of contents
- Applications
- Technical specifications
- Loading labels
- Survey of the system

Page

D2-1-2
D2-1-3
D2-1-4
D2-1-5
D2-1-6

D2-2 Crafty MF H100

- Kabelladders/Koppelplaten
- Koppelplaten
- Hoekkoppelplaat/Eindschot
- Hulpstukken/Deksels

D2-2-1
D2-2-2
D2-2-3
D2-2-4/8

D2-2 Crafty MF H100

- Cable ladders/Splice plates
- Splice plates
- Corner splice plate/End plate
- Fittings/Covers

D2-2-1
D2-2-2
D2-2-3
D2-2-4/8

D2-3 Crafty MF H150

- Kabelladders/Koppelplaten
- Koppelplaten
- Hoekkoppelplaat/Eindschot
- Hulpstukken/Deksels

D2-3-1
D2-3-2
D2-3-3
D2-3-4/8

D2-3 Crafty MF H150

- Cable ladders/Splice plates
- Splice plates
- Corner splice plate/End plate
- Fittings/Covers

D2-3-1
D2-3-2
D2-3-3
D2-3-4/8

Crafty MF Toepassingen

Crafty MF Applications

Crafty MF



Technische gegevens

Technical specifications

Materiaal kwaliteit

De kabelladders, koppelplaten, hulpstukken en deksels worden vervaardigd uit aluminium in de kwaliteit EN-AW-1050A.

Systeem

Crafty MF is een “heavy duty” kabelladder systeem. Crafty MF wordt geleverd in lengten van 3000 mm, in type H100 en type H150.

Crafty MF is volledig afsluitbaar met deksels in combinatie met dekselsluitingen. Het bodemprofiel en de zijwanden worden middels een lasconstructie aan elkaar bevestigd.

De kabelladder is **Multi-Functioneel**, doordat zijwanden en bodemprofiel zijn voorzien van een groot aantal extra perforaties. De ladder kan hierdoor op elke gewenste lengte worden afgekort, met behoud van koppelperforaties.

De perforaties in het bodemprofiel kunnen worden benut voor kabelbevestiging, verlichting en tubing.

Hulpstukken

Hulpstukken worden geleverd met een standaard radius van 300-600 mm. Het systeem kan worden gecompleteerd met diverse plafond- en wandbevestigingen, op aanvraag leverbaar in aluminium.

Material quality

The cable ladders, splice plates, fittings and covers are made of aluminium quality EN-AW-1050A.

System

Crafty MF is a “heavy duty” cable ladder system. Crafty MF is supplied in lengths of 3000 mm for type H100 and type H150.

Crafty MF is completely lockable with covers in combination with special cover fasteners. The base section and side walls are connected through a welding construction.

*The cable ladder is **Multi-Functional**, for its base sections and side walls are amply provided with perforations. Therefore, the ladder can be shortened to any desired length, preserving the splice perforations. The perforations in the base section can be used for the attachment of cables, illumination and tubing.*

Fittings

Fittings are supplied with a standard radius of 300-600 mm. The system can be completed with several ceiling- and wall-attachments, on demand it can be delivered in aluminium.

Technische gegevens

Technical specifications

Overspanningsklasse en belastbaarheid

Span category and load-bearing capacity

Crafty MF

Belastbaarheid

Crafty MF is belastbaar volgens de in de tabellen opgenomen gegevens. Om het draagvermogen te handhaven op plaatsen waar hulpstukken bevestigd zitten, moeten daar extra steunpunten worden aangebracht.

Overspanningsklasse

Crafty MF kan, met inachtneming van de maximale belastbaarheid, worden toegepast over een afstand van maximaal 3000 mm voor het type H100 en 4500 mm voor het type H150.

Maatwerk

Speciale materialen en maatvoeringen kunnen op klant specificaties gefabriceerd worden

Load-bearing Capacity

Crafty MF can be loaded within the limits indicated in the carrying capacity tables. In order to maintain the carrying capacity, additional support points are needed where fittings have been applied.

Span Category

Crafty MF can be installed over a maximum distance of 3000 mm for the H100 and 4500 mm for the H150 type.

Custom-made goods

Special materials and sizes can be made-to-measure on customer request.

Belastbaarheidstabel serie H100

Overspanning tot maximaal 3000 mm

Materiaaldikte zijwand: 2,5 mm

Materiaaldikte bodemprofielen: 2 mm

Veiligheidsfactor gerelateerd aan maximale belasting: 1,71

Loading table serie H100

Spans of up to 3000 mm

Material thickness side wall: 2.5 mm

Material thickness rungs: 2 mm

Safety factor related to maximum load: 1.71

Artikel nr. Product no.	Breedte mm Width mm	Gemiddelde belasting N/m bij max. vulling Av. load N/m at max. filling	Maximale belasting N/m Maximum load N/m		Doorbuiging mm Deflection mm	
			Overspanning m/Span m		Overspanning m/Span m	
			3	4,5	3	4,5
71002.235	200	250	800	op aanvraag on request	8	
71003.235	300	375	800		8	
71004.235	400	500	800		8	
71005.235	500	625	800		8	
71006.235	600	750	800		8	

Belastbaarheidstabel serie H150

Overspanning tot maximaal 4500 mm

Materiaaldikte zijwand: 2,5 mm

Materiaaldikte bodemprofielen: 2 mm

Veiligheidsfactor gerelateerd aan maximale belasting: 1,71

Loading table serie H150

Spans of up to 4500 mm

Material thickness side wall: 2.5 mm

Material thickness rungs: 2 mm

Safety factor related to maximum load: 1.71

Artikel nr. Product no.	Breedte mm Width mm	Gemiddelde belasting N/m bij max. vulling Av. load N/m at max. filling	Maximale belasting N/m Maximum load N/m		Doorbuiging mm Deflection mm	
			Overspanning m/Span m		Overspanning m/Span m	
			3	4,5	3	4,5
72002.235	200	400	1200	800	6	10
72003.235	300	600	1200	800	6	10
72004.235	400	800	1200	800	6	10
72005.235	500	1000	1200	800	6	10
72006.235	600	1200	1200	800	6	10

Systeemoverzicht Crafty MF

Survey of the system Crafty MF

Benaming / Description	H100		H150	
	pos. nr. item no.	pagina page	pos. nr. item no.	pagina page
Kabelladder/ Cable ladder ▶300 ◀	1	D2-2-1	17	D2-3-1
Koppelplaat 200 / Splice plate 200	2	D2-2-1	18	D2-3-1
Koppelplaat 500 / Splice plate 500	3	D2-2-2	19	D2-3-2
Scharnierende koppelplaat / Hinged splice plate	4	D2-2-2	20	D2-3-2
Horiz. scharnierende koppelplaat / Horiz. hinged splice plate	5	D2-2-2	21	D2-3-2
Expansie koppelplaat / Expansion splice plate	6	D2-2-2	22	D2-3-2
Hoekkoppelplaat / Corner splice plate	7	D2-2-3	23	D2-3-3
Hoekkoppelplaat / Corner splice plate	8	D2-2-3	24	D2-3-3
Scheidingsschot / Separation strip	9	D2-2-3	25	D2-3-3
Eindschot / Endplate	10	D2-2-3	26	D2-3-3
Verloopstuk / Reducer	11	D2-2-4	27	D2-3-4
Horizontaal bochtstuk 45° / Horizontal bend 45°	12	D2-2-5	28	D2-3-5
Horizontaal bochtstuk 90° / Horizontal bend 90°	13	D2-2-5	29	D2-3-5
Driewegstuk / Tee piece	14	D2-2-6	30	D2-3-6
Vierwegstuk / Cross piece	15	D2-2-7	31	D2-3-7
Verticaal bochtstuk 90° / Vertical bend 90°	16	D2-2-8	32	D2-3-8
Montagerail B21 / Hanger channel B21	33	E	33	E
Montagerail B41 / Hanger channel B41	34	E	34	E
Plafondbeugel / Ceiling brace	35	E	35	E
Railplaat / Rail plate	36	E	36	E
Moerplaat / Lock nut	37	E	37	E
Console-EZ / Bracket-EZ	38	E	38	E
Schoorconsole / Stanchion bracket	39	E	39	E
Console-Z / Bracket-Z	40	E	40	E
Console-ZV / Bracket-ZV	41	E	41	E
Consolehanger-ZV / Bracket hanger-ZV	42	E	42	E
Wandbeugel / Wall brace	43	E	43	E
Dekselsluiting / Cover fastener	44	D2-2-1	44	D2-3-1
Universele montageplaat / Mounting plate for socket box	45	E	45	E
Spanklauw A / Beam clamp A	46	E	46	E
Spanklauw B / Beam clamp B	47	E	47	E
Borgklem / Locking clip	48	E	48	E
Klembeugel / Assembly clamp	49	E	49	E
Afdichtstop / Seal cap	50	E	50	E
Draadstang / Threaded rod	51	E	51	E

Crafty MF

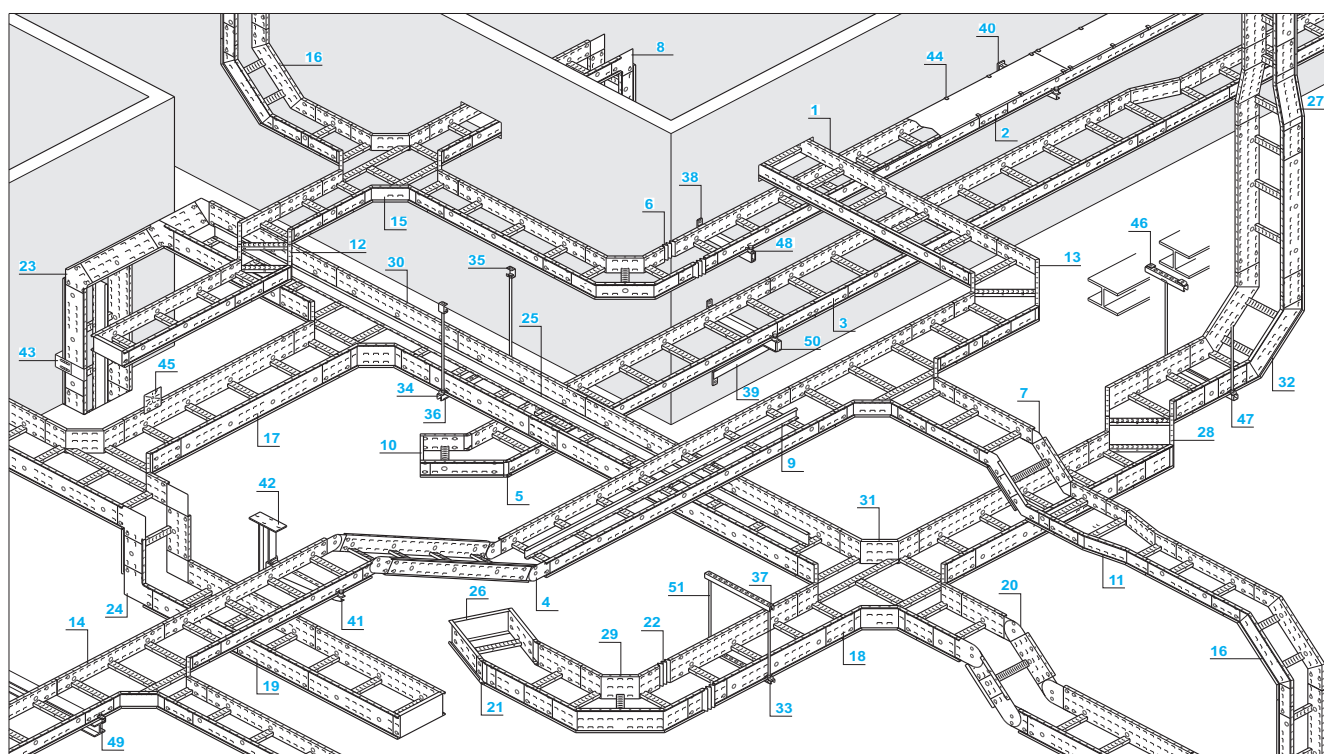

Crafty MF

H100

Kabelladder
Cable ladder

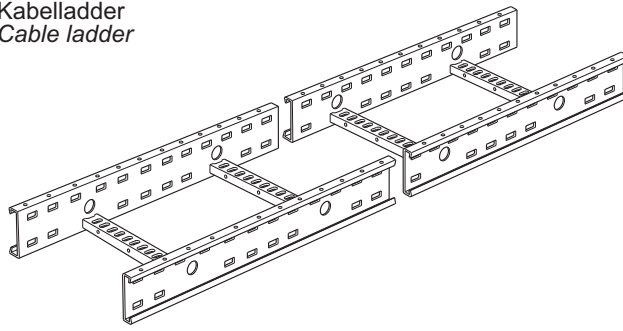

Dekselsluiting
Cover fastener

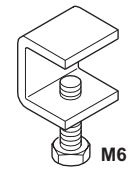

Crafty MF

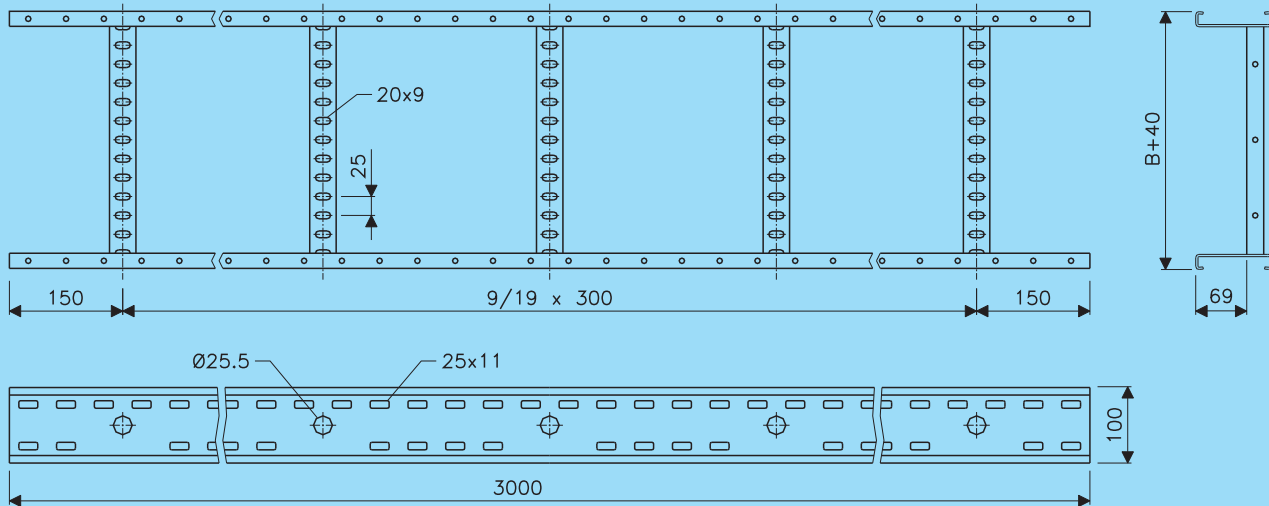

▶ 300 ◀ Hartafstand bodemprofielen
c.t.c. rung distance

kabelladderdeksels:
200 t/m 600 mm L=3000 mm

cabelladder covers:
200 up to 600 mm L=3000 mm

bestel de benodigde
koppelplaten apart,
zij worden niet
standaard geleverd
bij de kabelladders

order splice plates
as separate items,
they are not sup-
plied with the
cable ladders

Kabelladder Cable ladder ▶ 300 ◀				Kabelladderdeksel Cable ladder cover	
B	Artikel nr. Product no. L=3000	Gewicht Weight L=3000		Artikel nr. Product no.	Gewicht Weight
200	71002.235	6,64		74002.205	4,44
300	71003.235	7,07		74003.205	6,06
400	71004.235	7,50		74004.205	7,68
500	71005.235	7,93		74005.205	9,30
600	71006.235	8,36		74006.205	10,92

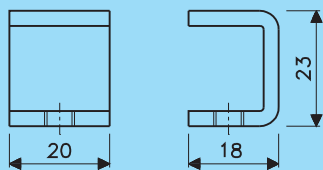

dekselsluitingen worden alleen
gebruikt bij rechte deksels
cover fasteners only to be used
with straight covers

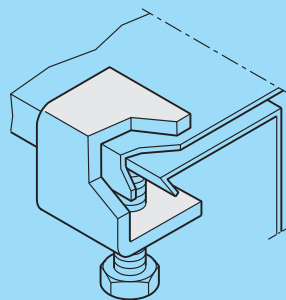

montage-toepassing
mounting application

Dekselsluiting Cover fastener	
Artikel nr. Product no.	Gewicht Weight
66065.204	0,03

bestel de benodigde deksel-
klemmen apart, zij worden
niet geleverd bij de deksels

order cover fasteners as
separate items, they are not
supplied with the covers

Koppelplaat 200/500
Splice plate 200/500

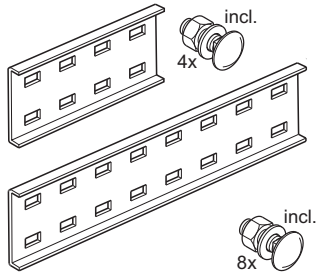

Vert. Scharn. koppelplaat
Vert. hinged splice plate

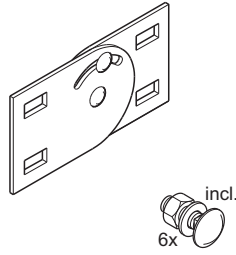

Horiz. scharn. koppelplaat
Horiz. hinged splice plate

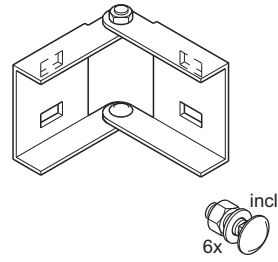

Expansie koppelplaat
Expansion splice plate

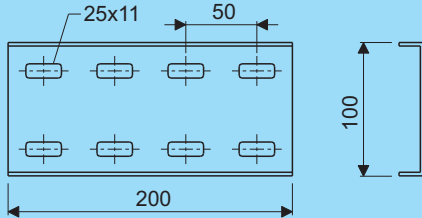
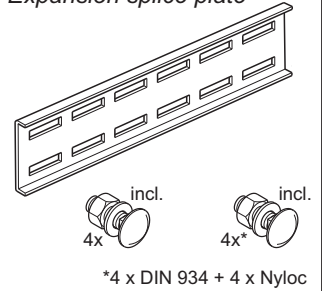

lichte uitvoering, voor toepassing bij overspanningen tot 3 meter en verloopkoppelplaten

light duty version, for use with spans upto 3 metres and reducing splice plates

Koppelplaat 200 <i>Splice plate 200</i>	
Artikel nr. <i>Product no.</i>	Gewicht <i>Weight</i>
71024.205	0,16

levering inclusief:
4 slotbouten M10 x 20, moeren en sluitringen
*supplied complete with:
4 lock screws M10 x 20, nuts and washers*

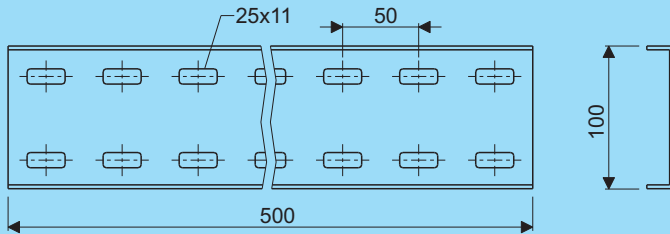

zware uitvoering, voor toepassing bij geconcentreerde belastingen en overspanning tot 4,5 meter

heavy duty version, for use with concentrated loads and spans upto 4.5 metres

Koppelplaat 500 <i>Splice plate 500</i>	
Artikel nr. <i>Product no.</i>	Gewicht <i>Weight</i>
71028.205	0,39

levering inclusief:
8 slotbouten M10 x 20, moeren en sluitringen
*supplied complete with:
8 lock screws M10 x 20, nuts and washers*

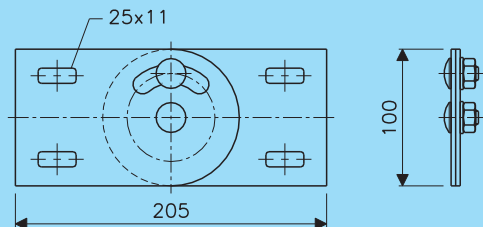

levering inclusief:
6 slotbouten M10 x 20, moeren en sluitringen
*supplied complete with:
6 lock screws M10 x 20, nuts and washers*

Vert. scharn. koppelplaat <i>Vert. hinged splice plate</i>	
Artikel nr. <i>Product no.</i>	Gewicht <i>Weight</i>
71030.205	0,17

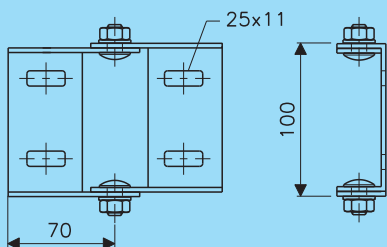

levering inclusief:
6 slotbouten M10 x 20, moeren en sluitringen
*supplied complete with:
6 lock screws M10 x 20, nuts and washers*

Horiz. scharn. koppelplaat <i>Horiz. hinged splice plate</i>	
Artikel nr. <i>Product no.</i>	Gewicht <i>Weight</i>
71032.205	0,14

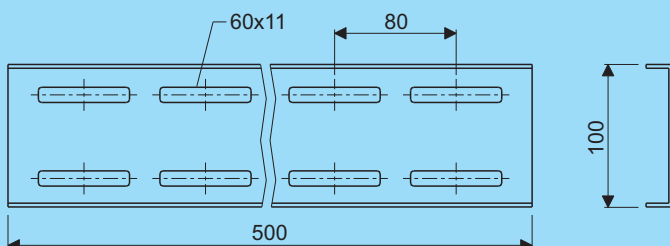

Expansie koppelplaat <i>Expansion splice plate</i>	
Artikel nr. <i>Product no.</i>	Gewicht <i>Weight</i>
71034.205	0,35

levering inclusief:
8 slotbouten M10 x 20, moeren en sluitringen*
*supplied complete with:
8 lock screws M10 x 20, nuts and washers**

*4 x DIN 934 + 4 x Nyloc

Crafty MF

H100

Hoekkoppelplaat
Corner splice plate

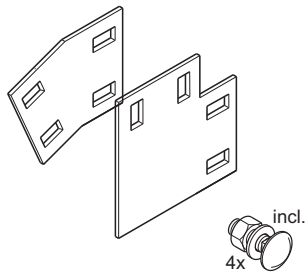

Scheidingsshot H56
Separation strip H56

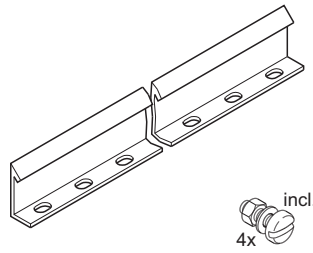

Eindschot
End plate

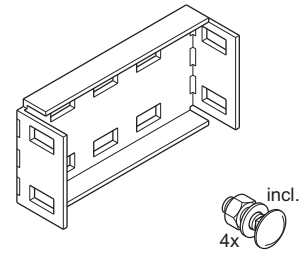

Crafty MF

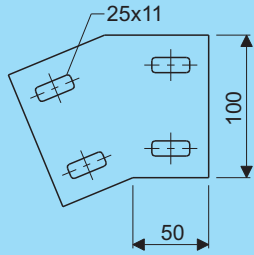

voor toepassing bij verticale bochtstukken en verval/stijgstukken te maken onder een vaste hoek

for use with vertical bends and vertical outer/inner bends in a fixed angle

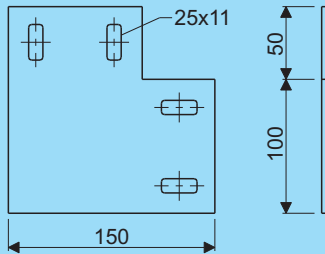

voor haakse verticale verbindingen van kabelladders

for vertical right-angle connections of cable ladders

Hoekkoppelplaat
Corner splice plate

\angle	Artikel nr. Product no.	Gewicht Weight
18°	71040.205	0,07
22,5°	71042.205	0,07
30°	71044.205	0,08
45°	71046.205	0,08
90°	71050.205	0,12

levering inclusief:
4 slotbouten M10 x 20,
moeren en sluitringen

supplied complete with:
4 lock screws M10 x 20,
nuts and washers

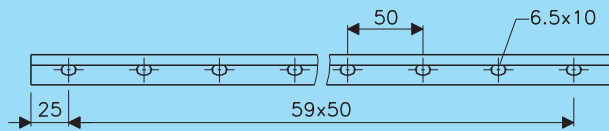

Scheidingsshot H56
Separation strip H56

Artikel nr. Product no.	Gewicht Weight
98743.205	0,64

levering inclusief:
4 slotbouten M6 x 12
en flensmoeren

supplied complete with:
4 lock screws M6 x 12
and flange nuts

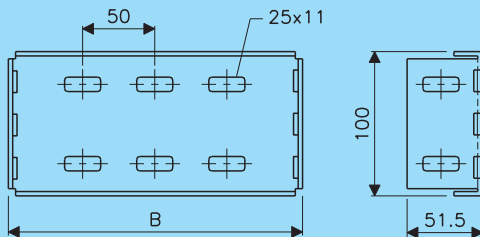
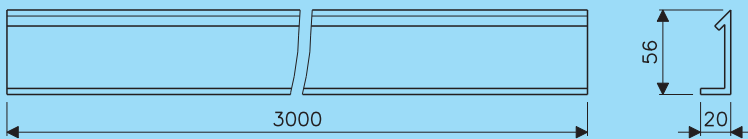

Eindschot
End plate

B	Artikel nr. Product no.	Gewicht Weight
200	71072.205	0,19
300	71073.205	0,27
400	71074.205	0,34
500	71075.205	0,42
600	71076.205	0,49

levering inclusief:
4 slotbouten M10 x 20,
moeren en sluitringen

supplied complete with:
4 lock screws M10 x 20,
nuts and washers

Crafty MF

H100

Verloopstuk
Reducer

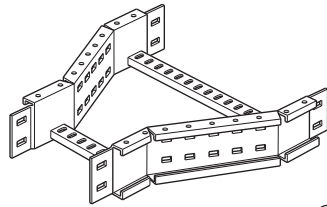

Verloopstuk links of rechts
Reducer left or right

op aanvraag
on request

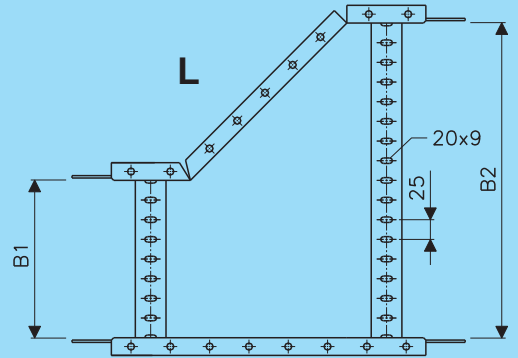
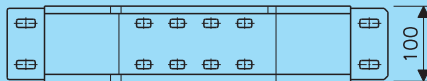
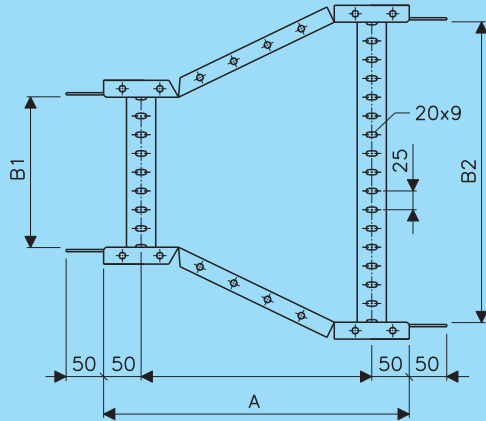
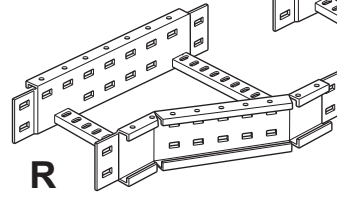

verloopstuk links
op aanvraag
reducer left
on request

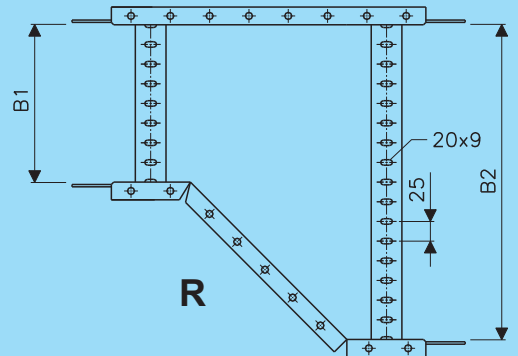

verloopstuk rechts
op aanvraag
reducer right
on request

levering inclusief:
8 slotbouten M10 x 20,
moeren en sluitringen
supplied complete with:
8 lock screws M10 x 20,
nuts and washers

Verloopstuk Reducer				Verloopstukdeksel Reducer cover	
B1 - B2	A	Artikel nr. Product no.	Gewicht Weight	Artikel nr. Product no.	Gewicht Weight
200 - 300	425	71104.235	1,19	74104.205	0,73
200 - 400	408	71105.235	1,23	74105.205	0,87
200 - 500	375	71106.235	1,27	74106.205	0,96
200 - 600	315	71107.235	1,32	74107.205	0,97
300 - 400	425	71108.235	1,27	74108.205	0,96
300 - 500	408	71109.235	1,32	74109.205	1,09
300 - 600	375	71110.235	1,36	74110.205	1,16
400 - 500	425	71111.235	1,36	74111.205	1,19
400 - 600	408	71112.235	1,40	74112.205	1,31
500 - 600	315	71114.235	1,45	74114.205	1,42

Crafty MF

H100

Horizontaal bochtstuk 45°
Horizontal bend 45°

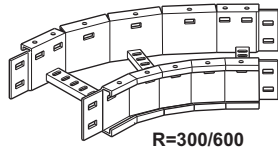

R=300/600



Horizontaal bochtstuk 90°
Horizontal bend 90°

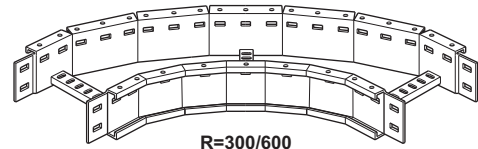

R=300/600



Crafty MF

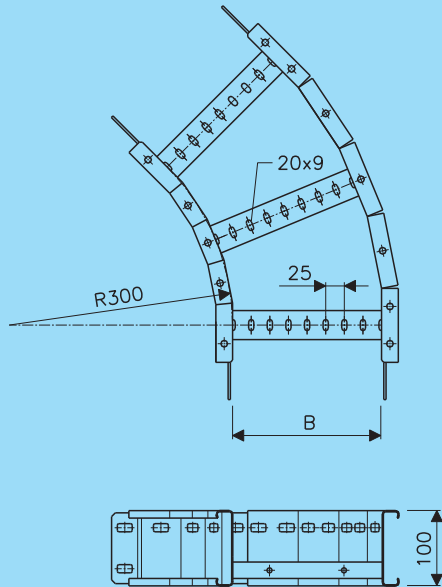

ook leverbaar hulpstukken > R=300
technische documentatie op aanvraag
also available fittings > R=300
technical documentation on request

Horizontaal bochtstuk 45° Horizontal bend 45°				
B	Artikel nr. Product no. R=300	Gewicht Weight R=300	Artikel nr. Product no. R=600	Gewicht Weight R=600
200	71162.235	1,19	71762.235	2,38
300	71163.235	1,41	71763.235	2,82
400	71164.235	1,62	71764.235	3,24
500	71165.235	1,82	71765.235	3,64
600	71166.235	2,03	71766.235	4,06

Horizontaal bochtstukdeksel 45° Horizontal bend cover 45°				
B	Artikel nr. Product no. R=300	Gewicht Weight R=300	Artikel nr. Product no. R=600	Gewicht Weight R=600
200	74162.205	0,47	74162.205	0,94
300	74163.205	0,76	74163.205	1,42
400	74164.205	1,09	74164.205	2,18
500	74165.205	1,46	74165.205	2,92
600	74166.205	1,87	74166.205	3,74

levering inclusief:
8 slotbouten M10 x 20,
moeren en sluitringen

supplied complete with:
8 lock screws M10 x 20,
nuts and washers

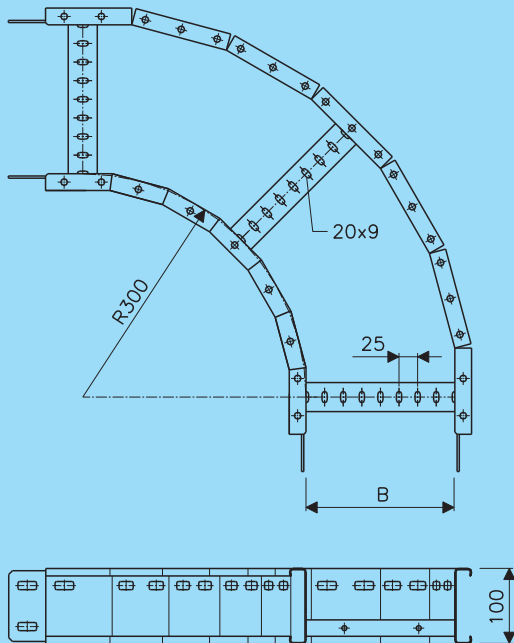

ook leverbaar hulpstukken > R=300
technische documentatie op aanvraag
also available fittings > R=300
technical documentation on request

Horizontaal bochtstuk 90° Horizontal bend 90°				
B	Artikel nr. Product no. R=300	Gewicht Weight R=300	Artikel nr. Product no. R=600	Gewicht Weight R=600
200	71182.235	1,82	71782.235	3,64
300	71183.235	2,22	71783.235	4,44
400	71184.235	2,56	71784.235	5,12
500	71185.235	3,56	71785.235	7,12
600	71186.235	4,00	71786.235	8,00

Horizontaal bochtstukdeksel 90° Horizontal bend cover 90°				
B	Artikel nr. Product no. R=300	Gewicht Weight R=300	Artikel nr. Product no. R=600	Gewicht Weight R=600
200	74182.205	0,81	74782.205	1,62
300	74183.205	1,33	74783.205	2,66
400	74184.205	1,93	74784.205	3,86
500	74185.205	2,62	74785.205	5,24
600	74186.205	3,40	74786.205	7,80

levering inclusief:
8 slotbouten M10 x 20,
moeren en sluitringen

supplied complete with:
8 lock screws M10 x 20,
nuts and washers

Crafty MF

H100

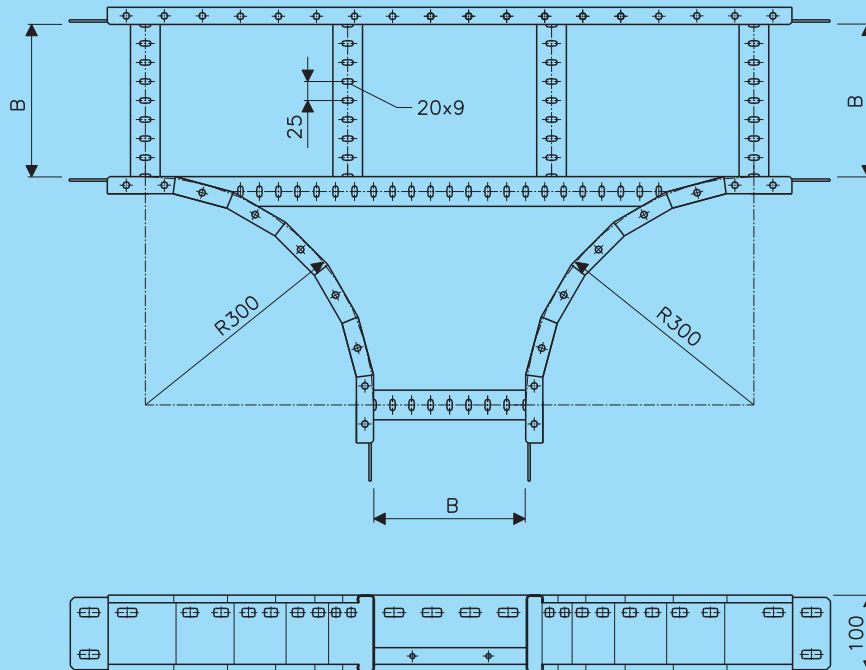
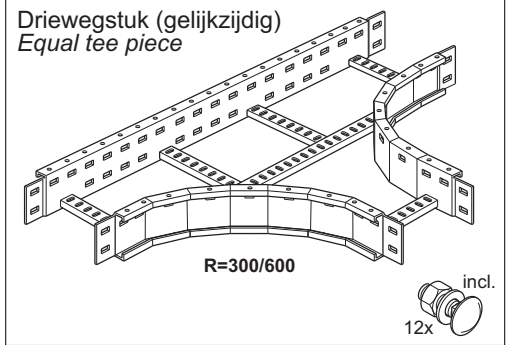

Driewegstuk (gelijkzijdig) Equal tee piece					Driewegstukdeksel (gelijkzijdig) Equal tee piece cover				
B	Artikel nr. Product no. R=300	Gewicht Weight R=300	Artikel nr. Product no. R=600	Gewicht Weight R=600	B	Artikel nr. Product no. R=300	Gewicht Weight R=300	Artikel nr. Product no. R=600	Gewicht Weight R=600
200	71222.235	2,88	71722.235	5,76	200	74222.205	2,02	74722.205	4,04
300	71223.235	3,24	71723.235	6,48	300	74223.205	2,87	74723.205	5,74
400	71224.235	3,59	71724.235	7,18	400	74224.205	3,83	74724.205	7,66
500	71225.235	4,16	71725.235	8,32	500	74225.205	4,89	74725.205	9,78
600	71226.235	4,56	71726.235	9,12	600	74226.205	6,07	74726.205	12,14

levering inclusief:
12 slotbouten M10 x 20,
moeren en sluitringen

supplied complete with:
12 lock screws M10 x 20,
nuts and washers

Crafty MF

H100

Vierwegstuk
Cross piece

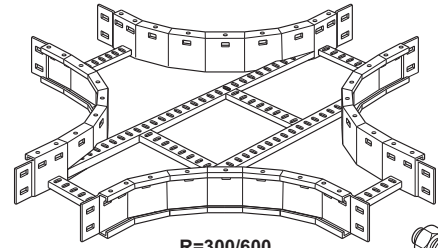

R=300/600

incl.
16x

Crafty MF

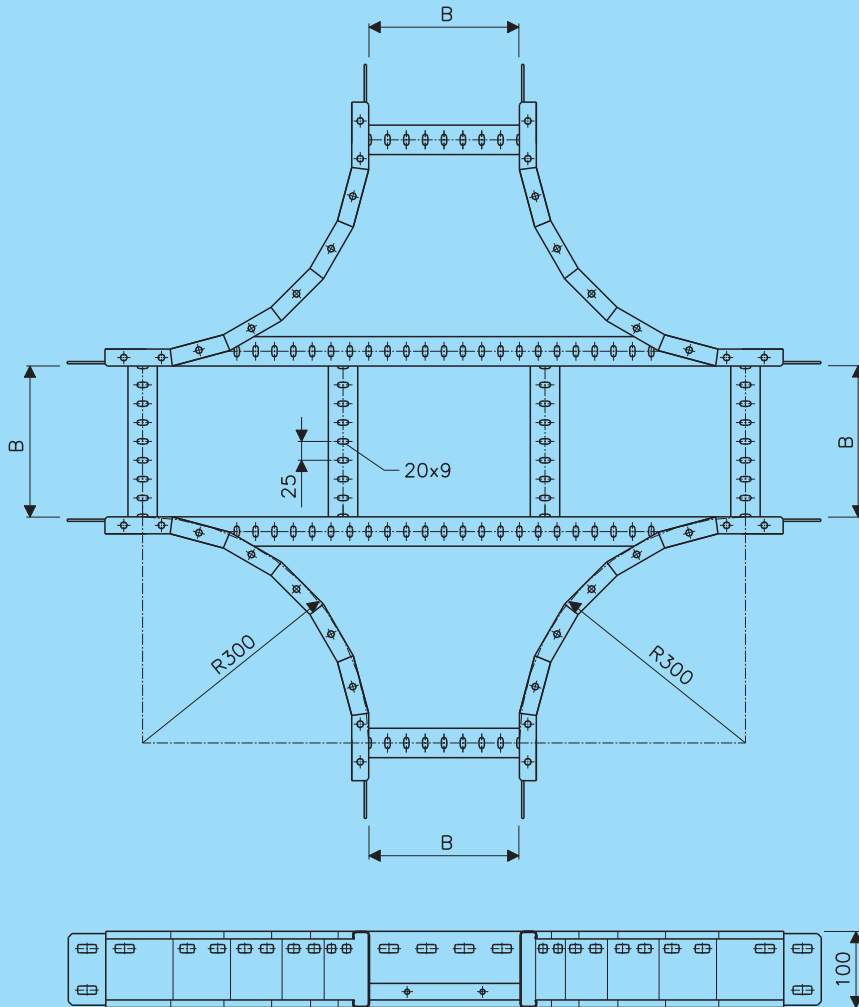

Vierwegstuk Cross piece								Vierwegstukdeksel Cross piece cover			
B1	B2	B3	B4	Artikel nr. Product no. R=300	Gewicht Weight R=300	Artikel nr. Product no. R=600	Gewicht Weight R=600	Artikel nr. Product no. R=300	Gewicht Weight R=300	Artikel nr. Product no. R=600	Gewicht Weight R=600
200	200	200	200	71302.235	3,54	71702.235	7,08	74302.205	2,85	74702.205	5,70
300	300	300	300	71303.235	3,89	71703.235	7,78	74303.205	3,87	74703.205	7,74
400	400	400	400	71304.235	4,23	71704.235	8,46	74304.205	5,01	74704.205	10,02
500	500	500	500	71305.235	4,79	71705.235	9,58	74305.205	6,25	74705.205	12,50
600	600	600	600	71306.235	5,18	71706.235	10,36	74306.205	7,60	74706.205	15,20

levering inclusief:
16 slotbouten M10 x 20,
moeren en sluitringen

supplied complete with:
16 lock screws M10 x 20,
nuts and washers

Crafty MF

H100

Stijgstuk 90°
Vertical inner bend 90°

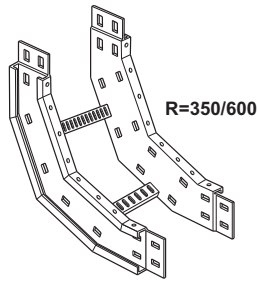

Vervalstuk 90°
Vertical outer bend 90°

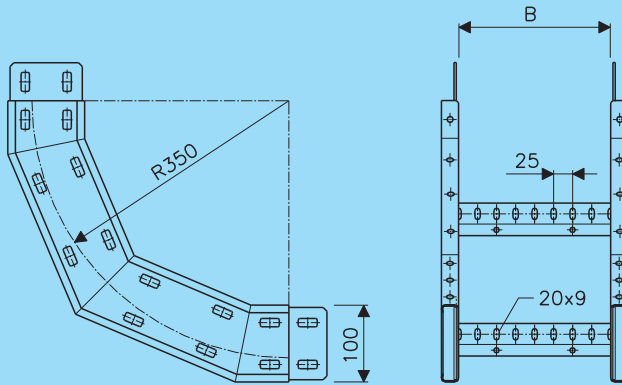
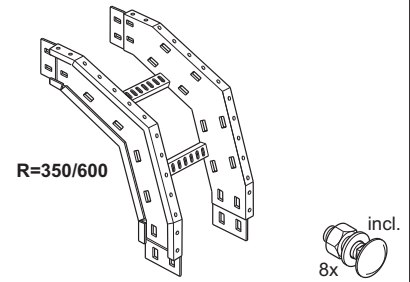

Stijgstuk 90° Vertical inner bend 90°				
B	Artikel nr. Product no. R=350	Gewicht Weight R=350	Artikel nr. Product no. R=600	Gewicht Weight R=600
200	71422.235	1,29	71722.235	2,58
300	71423.235	1,38	71723.235	2,76
400	71424.235	1,46	71724.235	2,92
500	71425.235	1,55	71725.235	3,10
600	71426.235	1,63	71726.235	3,26

Stijgstukdeksel 90° Vertical inner bend cover 90°				
B	Artikel nr. Product no. R=350	Gewicht Weight R=350	Artikel nr. Product no. R=600	Gewicht Weight R=600
200	74422.205	0,57	74722.205	1,14
300	74423.205	0,81	74723.205	1,62
400	74424.205	1,04	74724.205	2,08
500	74425.205	1,28	74725.205	2,56
600	74426.205	1,51	74726.205	3,02

levering inclusief:
8 slotbouten M10 x 20,
moeren en sluitringen
*supplied complete with:
8 lock screws M10 x 20,
nuts and washers*

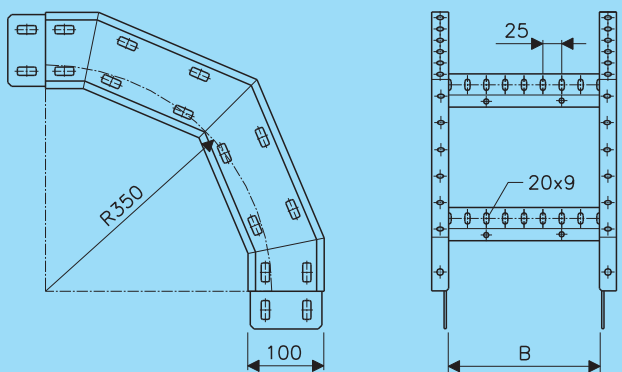

Vervalstuk 90° Vertical outer bend 90°				
B	Artikel nr. Product no. R=350	Gewicht Weight R=350	Artikel nr. Product no. R=600	Gewicht Weight R=600
200	71522.235	1,29	71722.235	2,58
300	71523.235	1,38	71723.235	2,76
400	71524.235	1,46	71724.235	2,92
500	71525.235	1,55	71725.235	3,10
600	71526.235	1,63	71726.235	3,26

Vervalstukdeksel 90° Vertical outer bend cover 90°				
B	Artikel nr. Product no. R=350	Gewicht Weight R=350	Artikel nr. Product no. R=600	Gewicht Weight R=600
200	74522.205	0,79	74722.205	1,58
300	74523.205	1,11	74723.205	2,22
400	74524.205	1,44	74724.205	2,88
500	74525.205	1,76	74725.205	3,52
600	74526.205	2,08	74726.205	4,16

levering inclusief:
8 slotbouten M10 x 20,
moeren en sluitringen
*supplied complete with:
8 lock screws M10 x 20,
nuts and washers*

Crafty MF

H150

Kabelladder
Cable ladder

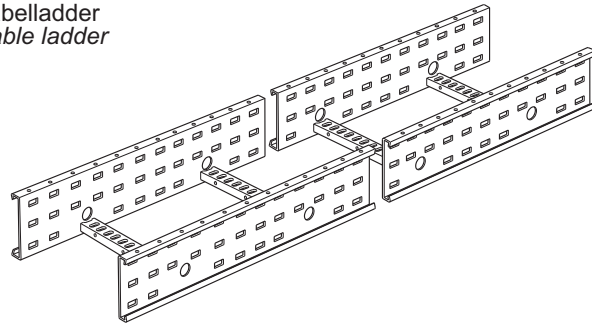

Dekselsluiting
Cover fastener

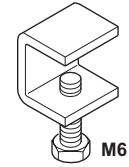

Crafty MF

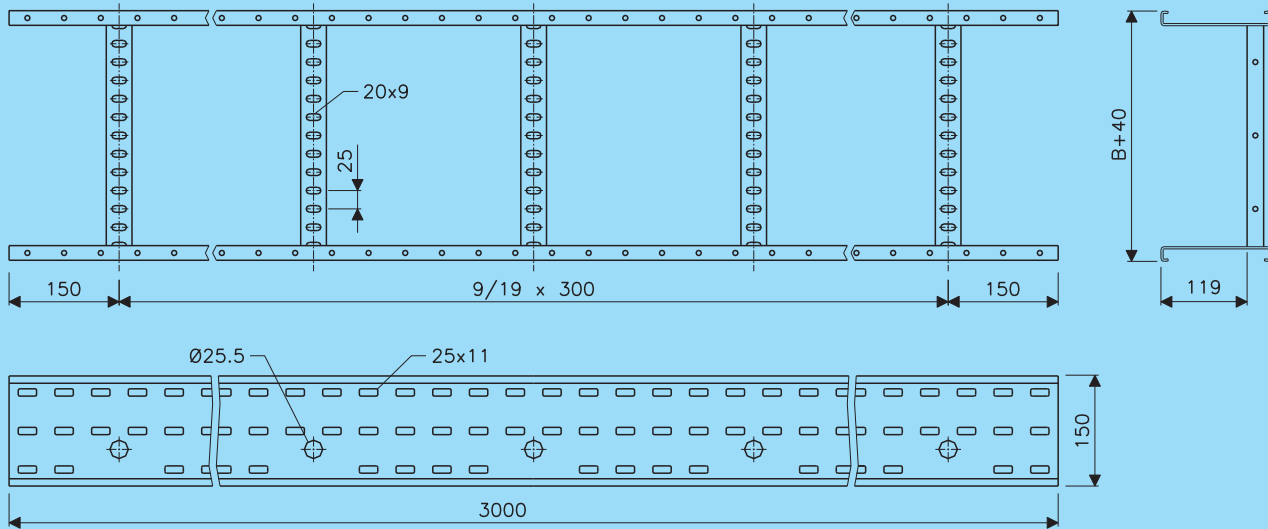

▶ 300 ◀ Hartafstand bodemprofielen
c.t.c. rung distance

kabelladderdeksels:
200 t/m 600 mm L=3000 mm

cover fasteners:
200 up to 600 mm L=3000 mm

bestel de benodigde
koppelplaten apart,
zij worden niet
standaard geleverd
bij de kabelladders

order splice plates
as separate items,
they are not sup-
plied with the
cable ladders

Kabelladder Cable ladder ▶ 300 ◀				Kabelladderdeksel Cable ladder cover	
B	Artikel nr. Product no. L=3000	Gewicht Weight L=3000		Artikel nr. Product no.	Gewicht Weight
200	72002.235	8,28		74002.205	4,44
300	72003.235	8,71		74003.205	6,06
400	72004.235	9,14		74004.205	7,68
500	72005.235	9,57		74005.205	9,30
600	72006.235	10,00		74006.205	10,92

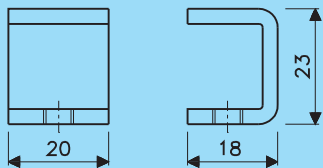

dekselsluitingen worden alleen
gebruikt bij rechte deksels
cover fasteners only to be used
with straight covers

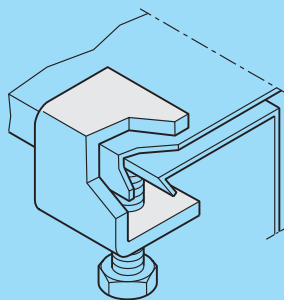

montage-toepassing
mounting application

Dekselsluiting Cover fastener	
Artikel nr. Product no.	Gewicht Weight
66065.204	0,03

bestel de benodigde deksel-
klemmen apart, zij worden
niet geleverd bij de deksels

order cover fasteners as
separate items, they are not
supplied with the covers

Koppelplaat 200/500
Splice plate 200/500

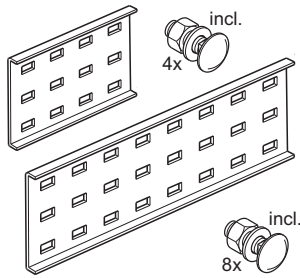

Vert. scharn. koppelplaat
Vert. hinged splice plate

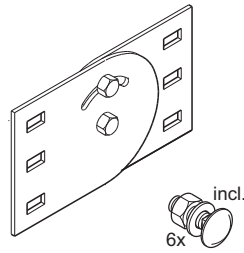

Horiz. scharn. koppelplaat
Horiz. hinged splice plate

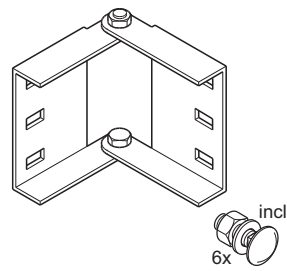

Expansie koppelplaat
Expansion splice plate

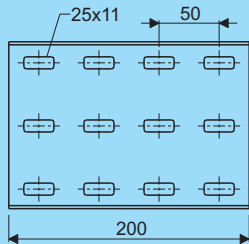
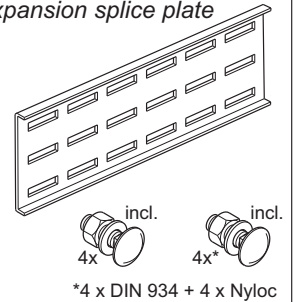

lichte uitvoering, voor toepassing bij overspanningen tot 3 meter en verloopkoppelplaten
light duty version, for use with spans up to 3 metres and reducing splice plates

levering inclusief:
4 slotbouten M10 x 20, moeren en sluitringen
*supplied complete with:
4 lock screws M10 x 20, nuts and washers*

Koppelplaat 200 Splice plate 200	
Artikel nr. Product no.	Gewicht Weight
72024.205	0,21

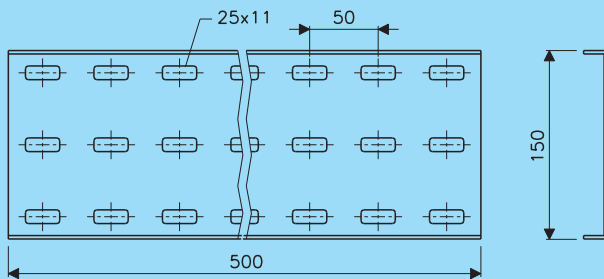

middelzware uitvoering, voor toepassing bij overspanningen tot 6 meter
medium duty version, for use with spans upto 6 metres

Koppelplaat 500 Splice plate 500	
Artikel nr. Product no.	Gewicht Weight
72028.205	0,52

levering inclusief:
8 slotbouten M10 x 20, moeren en sluitringen
*supplied complete with:
8 lock screws M10 x 20, nuts and washers*

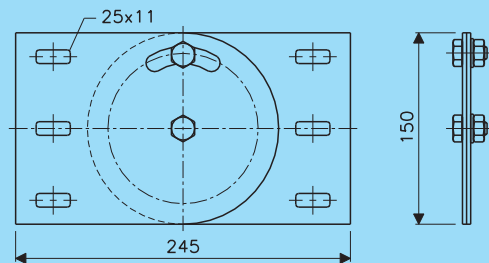

levering inclusief:
6 slotbouten M10 x 20, moeren en sluitringen
*supplied complete with:
6 lock screws M10 x 20, nuts and washers*

Vert. scharn. koppelplaat Vert. hinged splice plate	
Artikel nr. Product no.	Gewicht Weight
72030.205	0,30

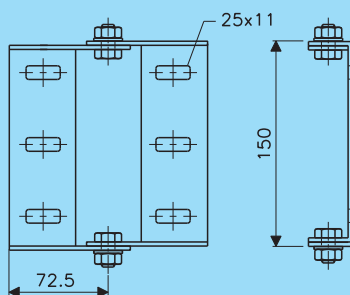

levering inclusief:
6 slotbouten M10 x 20, moeren en sluitringen
*supplied complete with:
6 lock screws M10 x 20, nuts and washers*

Horiz. scharn. koppelplaat Horiz. hinged splice plate	
Artikel nr. Product no.	Gewicht Weight
72032.205	0,19

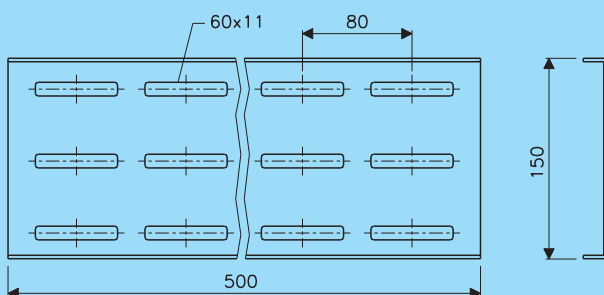

Expansie koppelplaat Expansion splice plate	
Artikel nr. Product no.	Gewicht Weight
72034.205	0,65

levering inclusief:
8 slotbouten M10 x 20, moeren en sluitringen*
*supplied complete with:
8 lock screws M10 x 20, nuts and washers**

*4 x DIN 934 + 4 x Nyloc

Crafty MF

H150

Hoekkoppelplaat
Corner splice plate

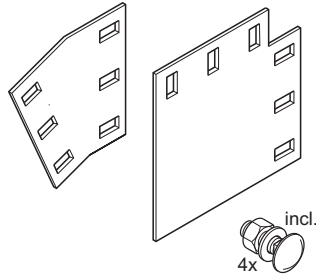

Scheidingsshot H86
Separation strip H86

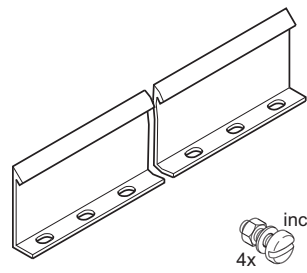

Eindschot
End plate

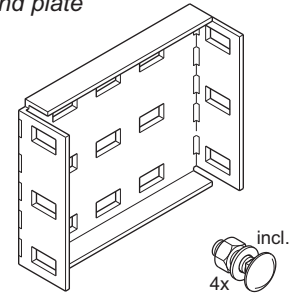

Crafty MF

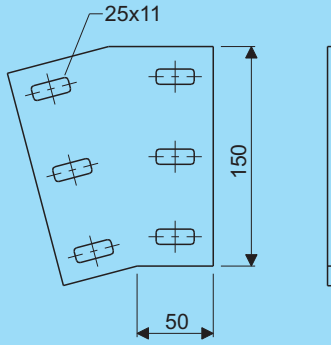

voor toepassing bij
verticale bochtstukken
en verval/stijgstukken
te maken onder een
vaste hoek

for use with vertical
bends and vertical
outer/inner bends in
a fixed angle

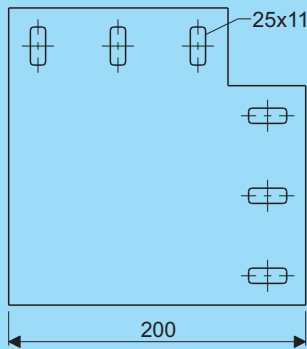

voor haakse verticale
verbindingen
van kabelladders
for vertical right-angle
connections of
cable ladders

Hoekkoppelplaat
Corner splice plate

\angle	Artikel nr. Product no.	Gewicht Weight
18°	72040.205	0,11
22,5°	72042.205	0,12
30°	72044.205	0,13
45°	72046.205	0,15
90°	72050.205	0,23

levering inclusief:
4 slotbouten M10 x 20,
moeren en sluitringen

supplied complete with:
4 lock screws M10 x 20,
nuts and washers

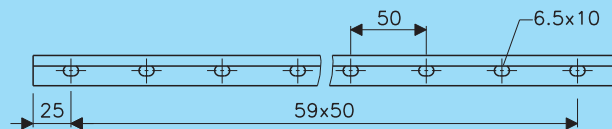

Scheidingsshot H86
Separation strip H86

Artikel nr. Product no.	Gewicht Weight
98745.205	0,89

levering inclusief:
4 slotbouten M6 x 12
en flensmoeren

supplied complete with:
4 lock screws M6 x 12
and flange nuts

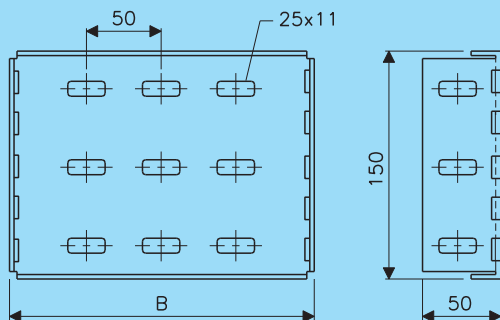
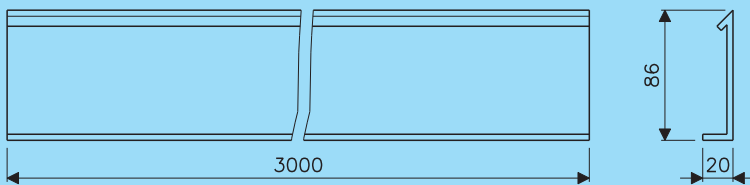

Eindschot
End plate

B	Artikel nr. Product no.	Gewicht Weight
200	72072.205	0,27
300	72073.205	0,37
400	72074.205	0,46
500	72075.205	0,56
600	72076.205	0,66

levering inclusief:
4 slotbouten M10 x 20,
moeren en sluitringen

supplied complete with:
4 lock screws M10 x 20,
nuts and washers

Crafty MF

H150

Verloopstuk
Reducer

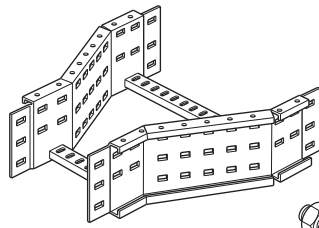

incl.
8x

Verloopstuk links of rechts
Reducer left or right

op aanvraag
on request

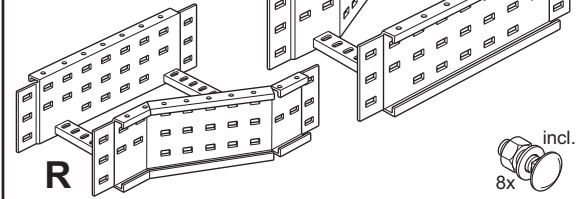

incl.
8x

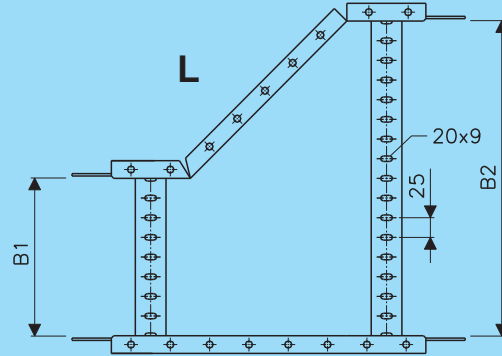
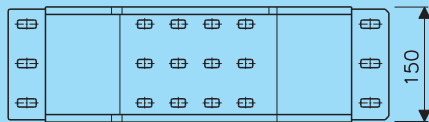
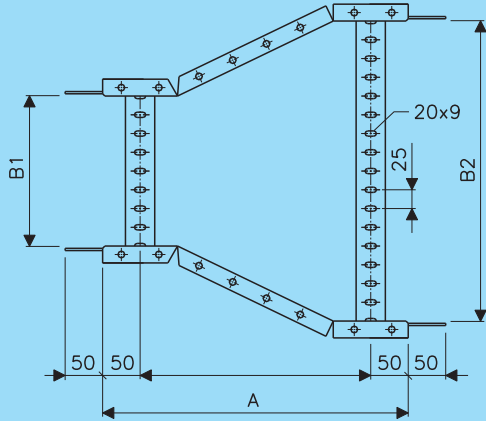

verloopstuk links
op aanvraag
reducer left
on request

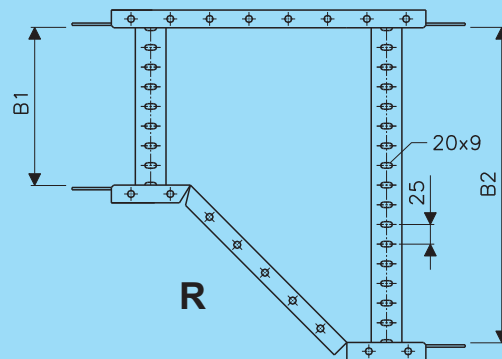

verloopstuk rechts
op aanvraag
reducer right
on request

levering inclusief:
8 slotbouten M10 x 20,
moeren en sluitringen
supplied complete with:
8 lock screws M10 x 20,
nuts and washers

Verloopstuk Reducer				Verloopstukdeksel Reducer cover	
B1 - B2	A	Artikel nr. Product no.	Gewicht Weight	Artikel nr. Product no.	Gewicht Weight
200 - 300	425	72104.235	1,51	74104.205	0,73
200 - 400	408	72105.235	1,55	74105.205	0,87
200 - 500	375	72106.235	1,59	74106.205	0,96
200 - 600	315	72107.235	1,64	74107.205	0,97
300 - 400	425	72108.235	1,59	74108.205	0,96
300 - 500	408	72109.235	1,64	74109.205	1,09
300 - 600	375	72110.235	1,68	74110.205	1,16
400 - 500	425	72111.235	1,68	74111.205	1,19
400 - 600	408	72112.235	1,72	74112.205	1,31
500 - 600	425	72114.235	1,77	74114.205	1,42

Crafty MF

H150

Horizontaal bochtstuk 45°
Horizontal bend 45°

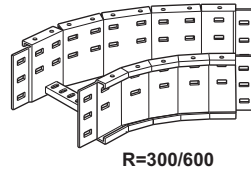

R=300/600



Horizontaal bochtstuk 90°
Horizontal bend 90°

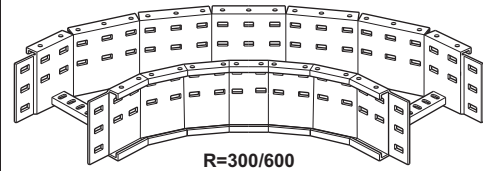

R=300/600



Crafty MF

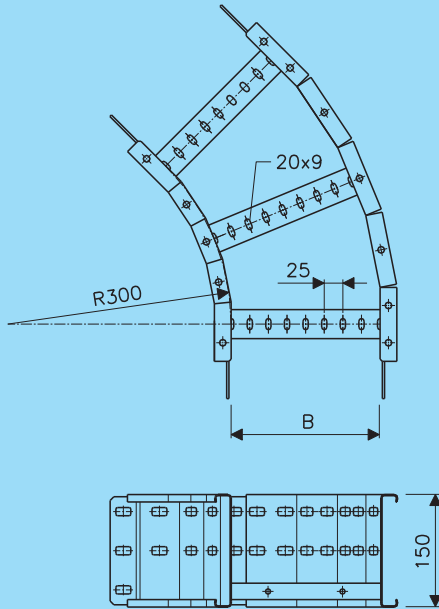

ook leverbaar hulpstukken > R=300
technische documentatie op aanvraag
also available fittings > R=300
technical documentation on request

Horizontaal bochtstuk 45° Horizontal bend 45°				
B	Artikel nr. Product no. R=300	Gewicht Weight R=300	Artikel nr. Product no. R=600	Gewicht Weight R=600
200	72162.235	1,50	72762.235	3,00
300	72163.235	1,74	72763.235	3,58
400	72164.235	1,98	72764.235	3,96
500	72165.235	2,20	72765.235	4,40
600	72166.235	2,44	72766.235	4,88

Horizontaal bochtstukdeksel 45° Horizontal bend cover 45°				
B	Artikel nr. Product no. R=300	Gewicht Weight R=300	Artikel nr. Product no. R=600	Gewicht Weight R=600
200	74162.205	0,47	74162.205	0,94
300	74163.205	0,76	74163.205	1,42
400	74164.205	1,09	74164.205	2,18
500	74165.205	1,46	74165.205	2,92
600	74166.205	1,87	74166.205	3,74

levering inclusief:
8 slotbouten M10 x 20,
moeren en sluitringen

supplied complete with:
8 lock screws M10 x 20,
nuts and washers

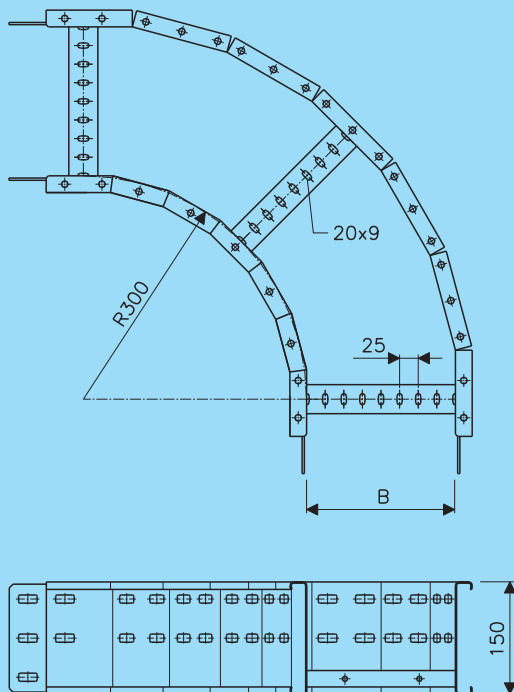

ook leverbaar hulpstukken > R=300
technische documentatie op aanvraag
also available fittings > R=300
technical documentation on request

Horizontaal bochtstuk 90° Horizontal bend 90°				
B	Artikel nr. Product no. R=300	Gewicht Weight R=300	Artikel nr. Product no. R=600	Gewicht Weight R=600
200	72182.235	2,34	72782.235	4,68
300	72183.235	2,78	72783.235	5,56
400	72184.235	3,18	72784.235	6,36
500	72185.235	4,22	72785.235	8,44
600	72186.235	4,71	72786.235	9,42

Horizontaal bochtstukdeksel 90° Horizontal bend cover 90°				
B	Artikel nr. Product no. R=300	Gewicht Weight R=300	Artikel nr. Product no. R=600	Gewicht Weight R=600
200	74182.205	0,81	74782.205	1,62
300	74183.205	1,33	74783.205	2,66
400	74184.205	1,93	74784.205	3,86
500	74185.205	2,62	74785.205	5,24
600	74186.205	3,40	74786.205	7,80

levering inclusief:
8 slotbouten M10 x 20,
moeren en sluitringen

supplied complete with:
8 lock screws M10 x 20,
nuts and washers

Crafty MF

H150

Driewegstuk (gelijkzijdig)
Equal tee piece

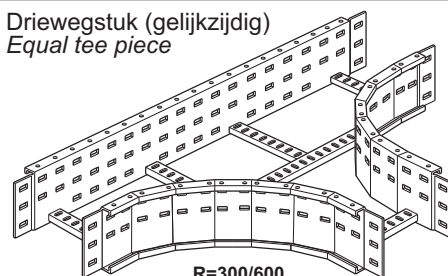

R=300/600

incl.
12x

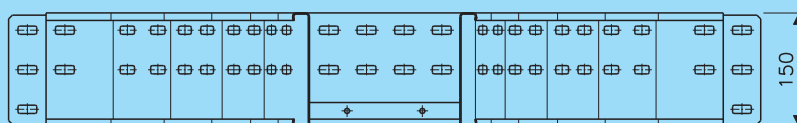
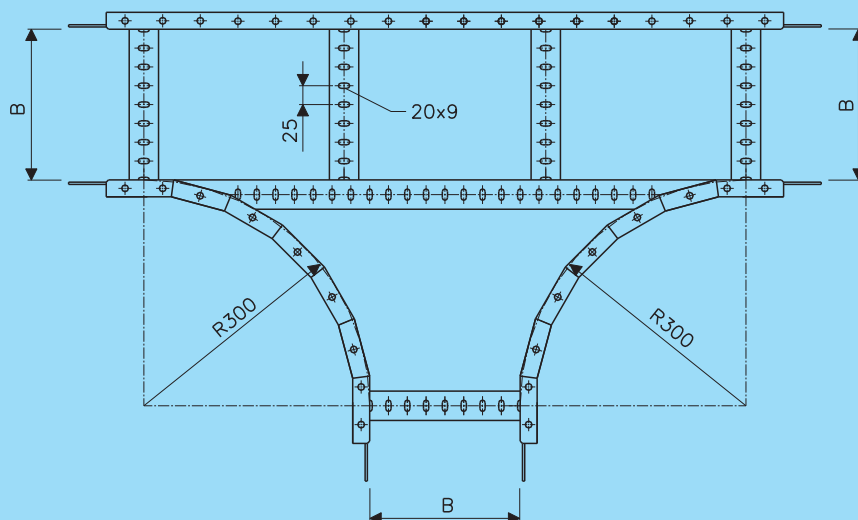

Driewegstuk (gelijkzijdig) Equal tee piece					Driewegstukdeksel (gelijkzijdig) Equal tee piece cover				
B	Artikel nr. Product no. R=300	Gewicht Weight R=300	Artikel nr. Product no. R=600	Gewicht Weight R=600	B	Artikel nr. Product no. R=300	Gewicht Weight R=300	Artikel nr. Product no. R=600	Gewicht Weight R=600
200	72222.235	3,60	72722.235	7,20	200	74222.205	2,02	74722.205	4,04
300	72223.235	3,99	72723.235	7,98	300	74223.205	2,87	74723.205	5,74
400	72224.235	4,37	72724.235	8,74	400	74224.205	3,83	74724.205	7,66
500	72225.235	4,98	72725.235	9,96	500	74225.205	4,89	74725.205	9,78
600	72226.235	5,41	72726.235	10,82	600	74226.205	6,07	74726.205	12,14

levering inclusief:
12 slotbouten M10 x 20,
moeren en sluitringen

supplied complete with:
12 lock screws M10 x 20,
nuts and washers

Crafty MF

H150

Vierwegstuk
Cross piece

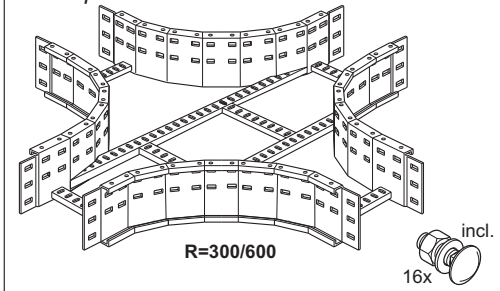

Crafty MF

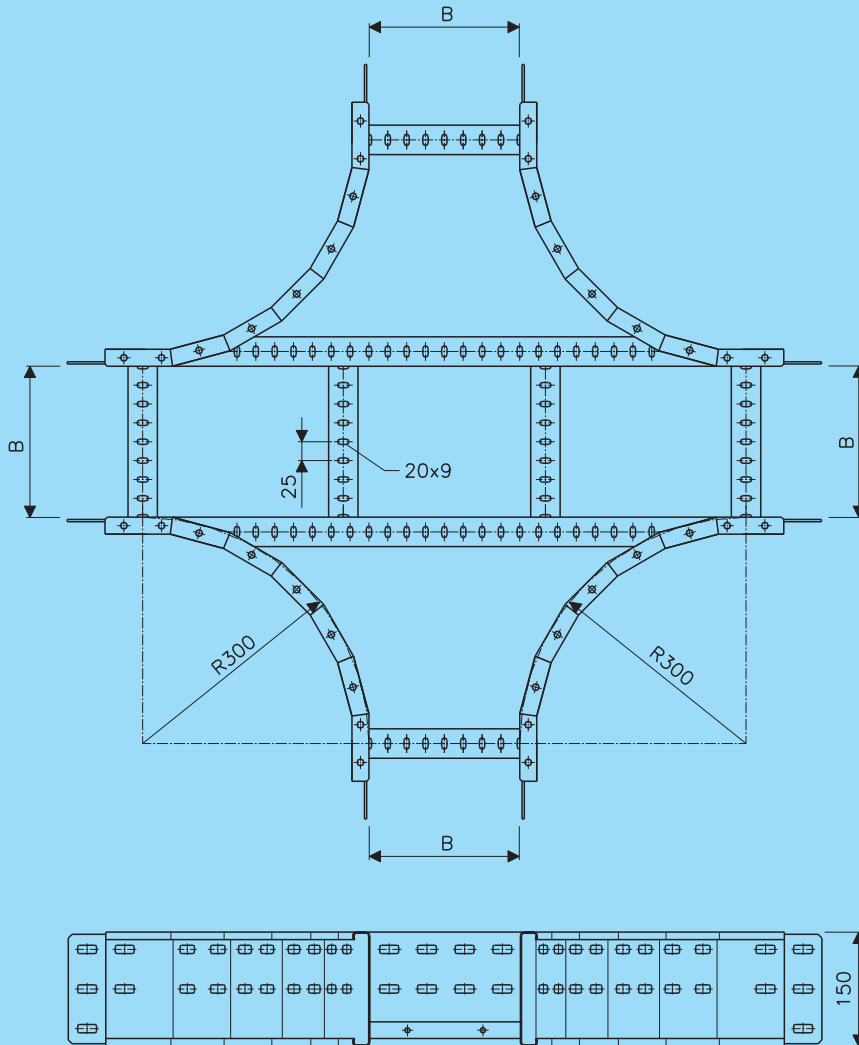

Vierwegstuk Cross piece								Vierwegstukdeksel Cross piece cover			
B1	B2	B3	B4	Artikel nr. Product no. R=300	Gewicht Weight R=300	Artikel nr. Product no. R=600	Gewicht Weight R=600	Artikel nr. Product no. R=300	Gewicht Weight R=300	Artikel nr. Product no. R=600	Gewicht Weight R=600
200	200	200	200	72302.235	4,37	72702.235	8,74	74302.205	2,85	74702.205	5,70
300	300	300	300	72303.235	4,72	72703.235	9,44	74303.205	3,87	74703.205	7,74
400	400	400	400	72304.235	5,06	72704.235	10,12	74304.205	5,01	74704.205	10,02
500	500	500	500	72305.235	5,62	72705.235	11,24	74305.205	6,25	74705.205	12,50
600	600	600	600	72306.235	6,01	72706.235	12,02	74306.205	7,60	74706.205	15,20

levering inclusief:
16 slotbouten M10 x 20,
moeren en sluitringen

supplied complete with:
16 lock screws M10 x 20,
nuts and washers

Crafty MF

H150

Stijgstuk 90°
Vertical inner bend 90°

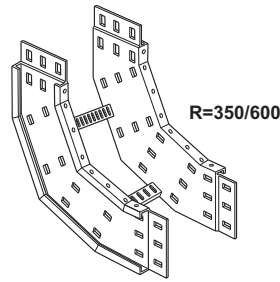

Vervalstuk 90°
Vertical outer bend 90°

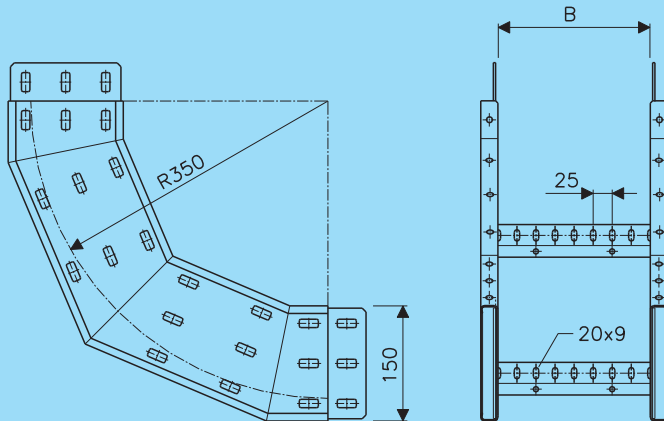
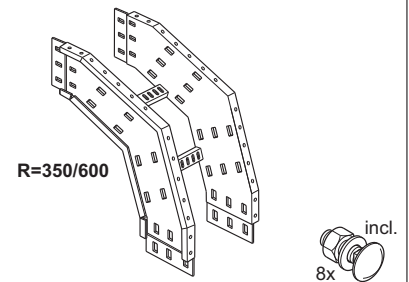

Stijgstuk 90° Vertical inner bend 90°				
B	Artikel nr. Product no. R=350	Gewicht Weight R=350	Artikel nr. Product no. R=600	Gewicht Weight R=600
200	72422.235	1,77	72722.235	3,54
300	72423.235	1,86	72723.235	3,72
400	72424.235	1,95	72724.235	3,90
500	72425.235	2,03	72725.235	4,06
600	72426.235	2,12	72726.235	4,24

Stijgstukdeksel 90° Vertical inner bend cover 90°				
B	Artikel nr. Product no. R=350	Gewicht Weight R=350	Artikel nr. Product no. R=600	Gewicht Weight R=600
200	74422.205	0,57	74722.205	1,14
300	74423.205	0,81	74723.205	1,62
400	74424.205	1,04	74724.205	2,08
500	74425.205	1,28	74725.205	2,56
600	74426.205	1,51	74726.205	3,02

levering inclusief:
8 slotbouten M10 x 20,
moeren en sluitringen
*supplied complete with:
8 lock screws M10 x 20,
nuts and washers*

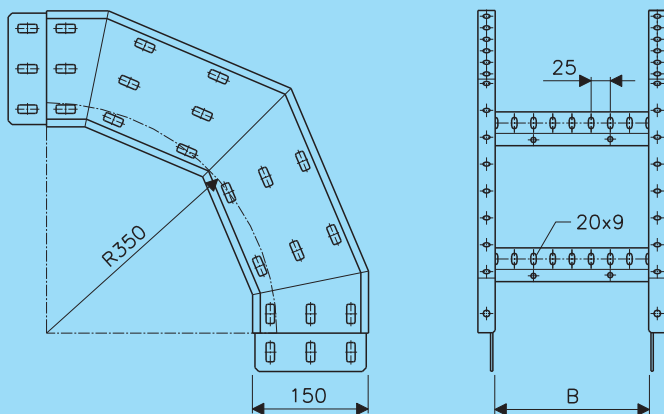

Vervalstuk 90° Vertical outer bend 90°				
B	Artikel nr. Product no. R=350	Gewicht Weight R=350	Artikel nr. Product no. R=600	Gewicht Weight R=600
200	72622.235	1,77	72722.235	3,54
300	72623.235	1,86	72723.235	3,72
400	72624.235	1,95	72724.235	3,90
500	72625.235	2,03	72725.235	4,06
600	72626.235	2,12	72726.235	4,24

Vervalstukdeksel 90° Vertical outer bend cover 90°				
B	Artikel nr. Product no. R=350	Gewicht Weight R=350	Artikel nr. Product no. R=600	Gewicht Weight R=600
200	74522.205	0,79	74722.205	1,58
300	74523.205	1,11	74723.205	2,22
400	74524.205	1,44	74724.205	2,88
500	74525.205	1,76	74725.205	3,52
600	74526.205	2,08	74726.205	4,16

levering inclusief:
8 slotbouten M10 x 20,
moeren en sluitringen
*supplied complete with:
8 lock screws M10 x 20,
nuts and washers*



GoudaHolland B.V.

P.O. Box 8
2850AA Haastrecht
The Netherlands

tel. +31 (0) 182-506200
fax. +31 (0) 182-506209

www.goudaholland.nl
info@goudaholland.nl



GoudaHolland

