



Kabelkanalen - Cable ducts

thermisch verzinkt

hot dip galvanized

C

Crafty MF H100/H150

Gouda Holland



Notities

Notes

Kabelkanalen Cable ducts



Crafty MF H100/H150

kabelladder

thermisch verzinkt

cable ladder

hot dip galvanized



Det Norske Veritas (DNV) en Germanischer Lloyd (GL)

Crafty MF



Crafty MF H100/H150

Kabelladder, Thermisch verzinkt

Cable ladder, Hot dip galvanized

- chemisch resistent
- thermisch verzinkt NEN-EN-ISO 1461
- afsluitbaar d.m.v. deksels
- standaardlengte 3000-6000 mm

Op verzoek:

- bodemprofielen h.o.h. 150 mm
- afwijkende breedte-, hoogte- en diktematen
- hulpstukken afwijkende radius

- *chemically resistant*
- *hot dip galvanized NEN-EN-ISO 1461*
- *a wide range of covers available*
- *standard length 3000-6000 mm*

On request:

- *rung distance c.t.c. 150 mm*
- *deviant width, height and thickness*
- *fittings deviant radius*

Crafty MF H100

Bodemprofielen h.o.h. 300 mm
Rung distance c.t.c. 300 mm

- materiaaldikte zijwand 1,5 mm
- materiaaldikte bodemprofiel 1,5 mm
- hulpstukken R = 300-600

- *material thickness sidewall 1.5 mm*
- *material thickness rung 1.5 mm*
- *fittings R = 300-600*

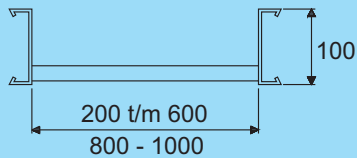

overspanning tot max. 4,5 meter
max. span: 4.5 mtr.

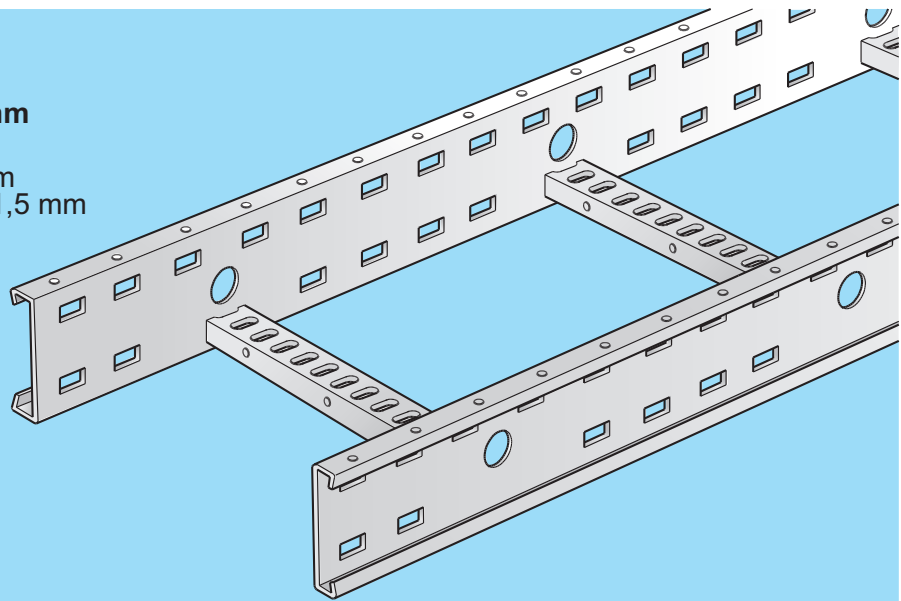

Crafty MF H150

Bodemprofielen h.o.h. 300 mm
Rung distance c.t.c. 300 mm

- materiaaldikte zijwand 2 mm
- materiaaldikte bodemprofiel 1,5 mm
- hulpstukken R = 300-600

- *material thickness sidewall 2 mm*
- *material thickness rung 1.5 mm*
- *fittings R = 300-600*

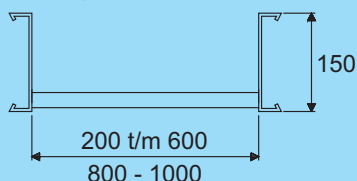

overspanning tot max. 6 meter
max. span: 6 mtr.

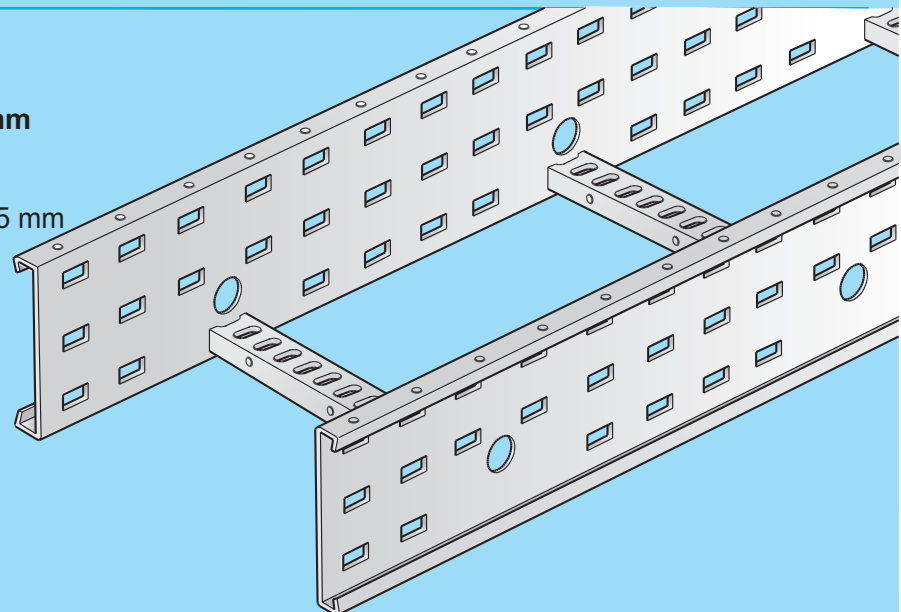

Kabelkanalen Crafty MF

Cable ducts Crafty MF

Kabelladder, Thermisch verzinkt

Cable ladder, Hot dip galvanized

C4-1 Algemeen

Pag.

- Inhoudsopgave C4-1-2
- Toepassingen C4-1-3
- Technische gegevens C4-1-4
- Belastbaarheidstabellen C4-1-5
- Systemoverzicht C4-1-6

C4-2 Crafty MF H100

- Kabelladders/Koppelplaten C4-2-1
- Koppelplaten C4-2-2
- Hoekkoppelplaat/Eindschot C4-2-3
- Hulpstukken/Deksels C4-2-4/8

C4-3 Crafty MF H150

- Kabelladders/Koppelplaten C4-3-1
- Koppelplaten C4-3-2
- Hoekkoppelplaat/Eindschot C4-3-3
- Hulpstukken/Deksels C4-3-4/8

C4-1 General

Page

- Table of contents C4-1-2
- Applications C4-1-3
- Technical specifications C4-1-4
- Loading labels C4-1-5
- Survey of the system C4-1-6

C4-2 Crafty MF H100

- Cable ladders/Splice plates C4-2-1
- Splice plates C4-2-2
- Corner splice plate/End plate C4-2-3
- Fittings/Covers C4-2-4/8

C4-3 Crafty MF H150

- Cable ladders/Splice plates C4-3-1
- Splice plates C4-3-2
- Corner splice plate/End plate C4-3-3
- Fittings/Covers C4-3-4/8

Crafty MF Toepassingen

Crafty MF Applications

Crafty MF



Technische gegevens

Technical specifications

Materiaal kwaliteit

De kabelladders, koppelplaten, hulpstukken, deksels alsmede de ophang-inrichtingen worden verzinkt volgens NEN-EN-ISO 1461.

Volgens deze norm kan bij dunne plaat vervorming ontstaan.

Systeem

Crafty MF is een "heavy duty" kabelladder systeem. Crafty MF wordt geleverd in lengten van 3000 en 6000 mm, in type H100 en type H150.

Crafty MF is volledig afsluitbaar met deksels in combinatie met dekselsluitingen. Het bodemprofiel en de zijwanden worden middels een lasconstructie aan elkaar bevestigd.

De kabelladder is **Multi-Functioneel**, doordat zijwanden en bodemprofiel zijn voorzien van een groot aantal extra perforaties. De ladder kan hierdoor op elke gewenste lengte worden afgekort, met behoud van koppelperforaties.

De perforaties in het bodemprofiel kunnen worden benut voor kabelbevestiging, verlichting en tubing.

Hulpstukken

Hulpstukken worden geleverd met een standaard radius van 300 en 600 mm. Het systeem kan worden gecompleteerd met diverse plafond- en wandbevestigingen (zie hoofdstuk **E**).

Material quality

The cable ladders, splice plates, fittings, covers and suspension constructions are galvanized according to NEN-EN-ISO 1461.

This norm allows deformation of thin plates.

System

Crafty MF is a "heavy duty" cable ladder system. Crafty MF is supplied in lengths of 3000 and 6000 mm for type H100 and type H150.

Crafty MF is completely lockable with covers in combination with special cover fasteners. The base section and side walls are connected through a welding construction.

*The cable ladder is **Multi-Functional**, for its base sections and side walls are amply provided with perforations. Therefore, the ladder can be shortened to any desired length, preserving the splice perforations. The perforations in the base section can be used for the attachment of cables, illumination and tubing.*

Fittings

*Fittings are supplied with a standard radius of 300 and 600 mm. The system can be completed with several ceiling- and wall-attachments (see chapter **E**).*

Technische gegevens

Technical specifications

Overspanningsklasse en belastbaarheid

Span category and load-bearing capacity

Belastbaarheid

Crafty MF is belastbaar volgens de in de tabellen opgenomen gegevens. Om het draagvermogen te handhaven op plaatsen waar hulpstukken bevestigd zitten, moeten daar extra steunpunten worden aangebracht.

Overspanningsklasse

Crafty MF kan, met inachtneming van de maximale belastbaarheid, worden toegepast over een afstand van maximaal 4500 mm voor het type H100 en 6000 mm voor het type H150.

Maatwerk

Speciale materialen en maatvoeringen kunnen op klant specificaties gefabriceerd worden

Load-bearing Capacity

Crafty MF can be loaded within the limits indicated in the carrying capacity tables. In order to maintain the carrying capacity, additional support points are needed where fittings have been applied.

Span Category

Crafty MF can be installed over a maximum distance of 4500 mm for the H100 and 6000 mm for the H150 type.

Custom-made goods

Special materials and sizes can be made-to-measure on customer request.

Belastbaarheidstabel serie H100

Overspanning tot maximaal 4500 mm
Materiaaldikte zijwand: 1,5 mm
Materiaaldikte bodemprofielen: 1,5 mm
Veiligheidsfactor gerelateerd aan maximale belasting: 1,71

Loading table serie H100

Spans of up to 4500 mms
Material thickness side wall: 1.5 mm
Material thickness rungs: 1.5 mm
Safety factor related to maximum load: 1.71

Artikel nr. Product no.	Breedte mm Width mm	Gemiddelde belasting N/m bij max. vulling Av. load N/m at max. filling	Maximale belasting N/m Maximum load N/m		Doorbuiging mm Deflection mm	
			Overspanning m/Span m		Overspanning m/Span m	
			3	4,5	3	4,5
71002.233	200	250	2200	1000	8	12
71003.233	300	375	2200	1000	8	12
71004.233	400	500	2200	1000	8	12
71005.233	500	625	2200	1000	8	12
71006.233	600	750	2200	1000	8	12
71008.233	800	1000	2200	1000	8	12
71010.233	1000	1250	2200	1000	8	12

Belastbaarheidstabel serie H150

Overspanning tot maximaal 6000 mm
Materiaaldikte zijwand: 2 mm
Materiaaldikte bodemprofielen: 1,5 mm
Veiligheidsfactor gerelateerd aan maximale belasting: 1,71

Loading table serie H150

Spans of up to 6000 mms
Material thickness side wall: 2 mm
Material thickness rungs: 1.5 mm
Safety factor related to maximum load: 1.71

Artikel nr. Product no.	Breedte mm Width mm	Gemiddelde belasting N/m bij max. vulling Av. load N/m at max. filling	Maximale belasting N/m Maximum load N/m			Doorbuiging mm Deflection mm		
			Overspanning m/Span m			Overspanning m/Span m		
			3	4,5	6	3	4,5	6
72002.233	200	400	2400	1400	1000	6	8	14
72003.233	300	600	2400	1400	1000	6	8	14
72004.233	400	800	2400	1400	1000	6	8	14
72005.233	500	1000	2400	1400	1000	6	8	14
72006.233	600	1200	2400	1400	1000	6	8	14
72008.233	800	1600	2400	1400	1000	6	8	14
72010.233	1000	2000	2400	1400	1000	6	8	14

Systeemoverzicht Crafty MF

Survey of the system Crafty MF

Benaming / Description	H100		H150	
	pos. nr. item no.	pagina page	pos. nr. item no.	pagina page
Kabelladder/ Cable ladder ▶300◀	1	C4-2-1	17	C4-3-1
Koppelplaat 200 / Splice plate 200	2	C4-2-1	18	C4-3-1
Koppelplaat 500 / Splice plate 500	3	C4-2-2	19	C4-3-2
Scharnierende koppelplaat / Hinged splice plate	4	C4-2-2	20	C4-3-2
Horiz. scharnierende koppelplaat / Horiz. hinged splice plate	5	C4-2-2	21	C4-3-2
Expansie koppelplaat / Expansion splice plate	6	C4-2-2	22	C4-3-2
Hoekkoppelplaat / Corner splice plate	7	C4-2-3	23	C4-3-3
Hoekkoppelplaat / Corner splice plate	8	C4-2-3	24	C4-3-3
Scheidingsschot / Separation strip	9	C4-2-3	25	C4-3-3
Eindschot / Endplate	10	C4-2-3	26	C4-3-3
Verloopstuk / Reducer	11	C4-2-4	27	C4-3-4
Horizontaal bochtstuk 45° / Horizontal bend 45°	12	C4-2-5	28	C4-3-5
Horizontaal bochtstuk 90° / Horizontal bend 90°	13	C4-2-5	29	C4-3-5
Driewegstuk / Tee piece	14	C4-2-6	30	C4-3-6
Vierwegstuk / Cross piece	15	C4-2-7	31	C4-3-7
Stijg-/vervalstuk 90° / Vertical inner-/outer bend 90°	16	C4-2-8	32	C4-3-8
Montagerail B21 / Hanger channel B21	33	E	33	E
Montagerail B41 / Hanger channel B41	34	E	34	E
Plafondbeugel / Ceiling brace	35	E	35	E
Railplaat / Rail plate	36	E	36	E
Moerplaat / Lock nut	37	E	37	E
Console-EZ / Bracket-EZ	38	E	38	E
Schoorconsole / Stanchion bracket	39	E	39	E
Console-Z / Bracket-Z	40	E	40	E
Console-ZV / Bracket-ZV	41	E	41	E
Consolehanger-ZV / Bracket hanger-ZV	42	E	42	E
Wandbeugel / Wall brace	43	E	43	E
Dekselsluiting / Cover fastener	44	C4-2-1	44	C4-2-1
Universele montageplaat / Mounting plate for socket box	45	E	45	E
Spanklauw A / Beam clamp A	46	E	46	E
Spanklauw B / Beam clamp B	47	E	47	E
Borgklem / Locking clip	48	E	48	E
Wing-clamp / Wing-clamp	49	E	49	E
Afdichtstop / Seal cap	50	E	50	E
Draadstang / Threaded rod	51	E	51	E

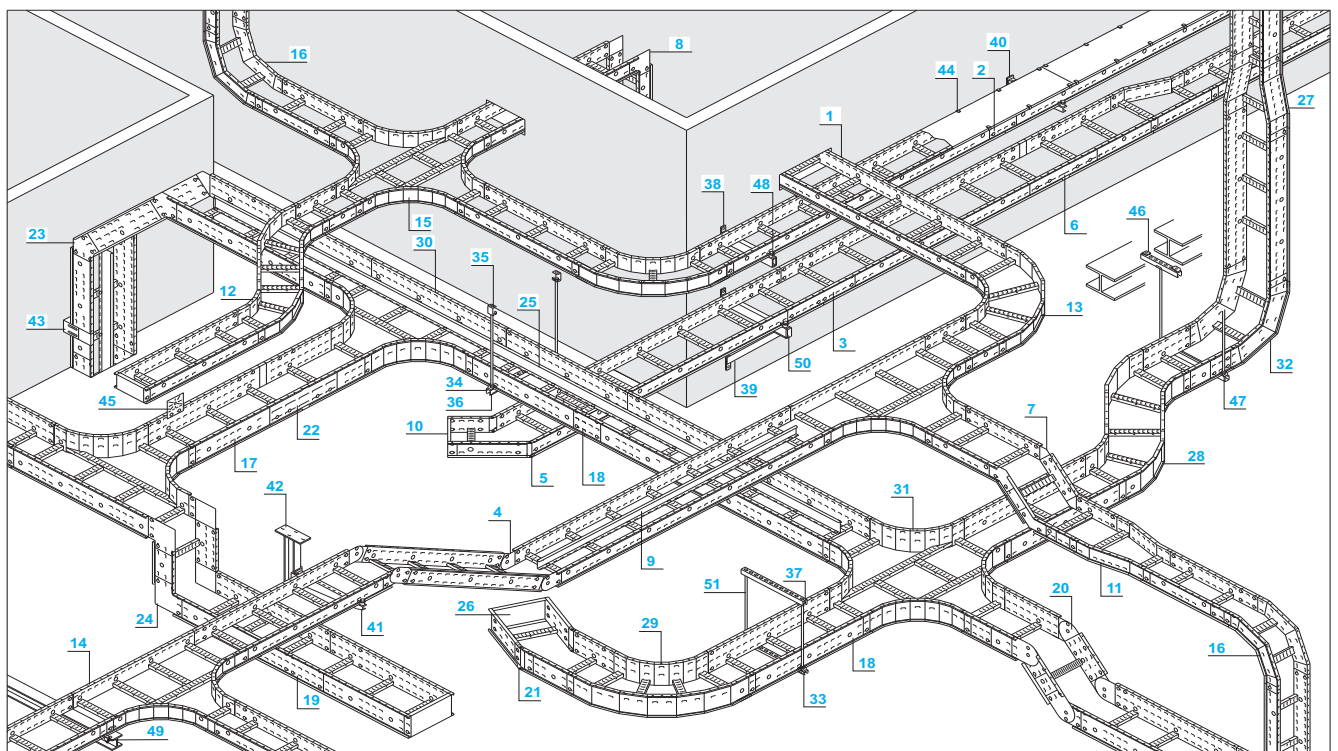

Crafty MF

H100

Kabelladder
Cable ladder

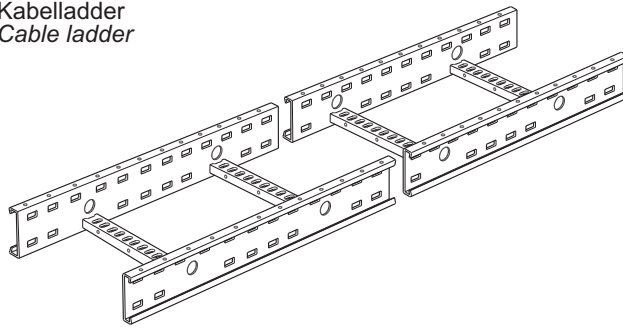

Dekselsluiting
Cover fastener

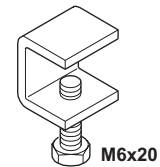

M6x20

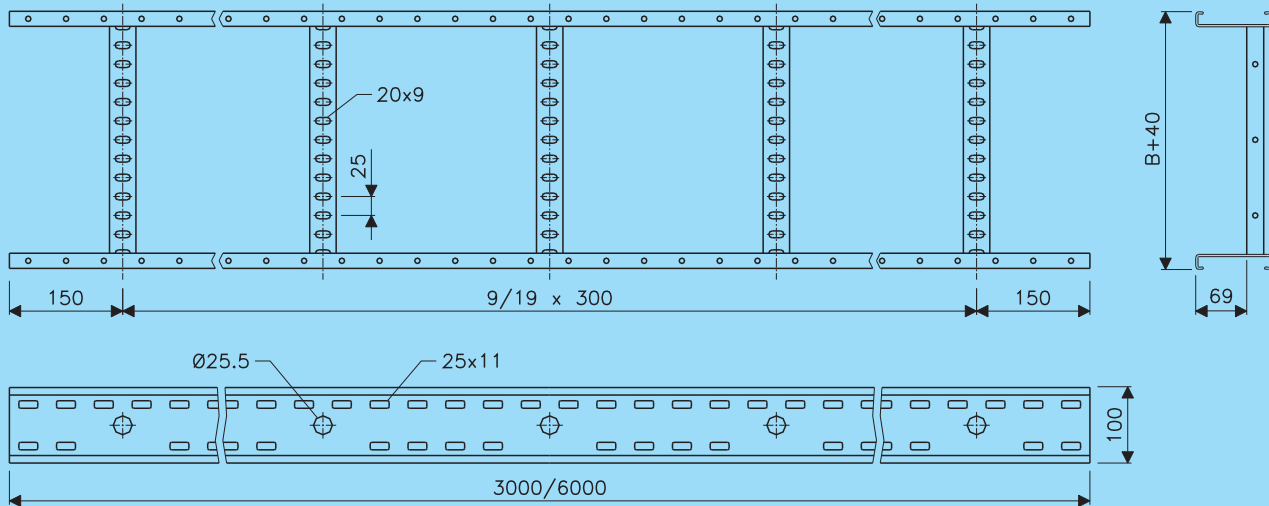

▶ 300 ◀ Hartafstand bodemprofielen
c.t.c. rung distance

kabelladderdeksels:
200 t/m 600 mm L=3000 mm
800 mm L=1500 mm
1000 mm L=1000 mm

cabelladder covers:
200 up to 600 mm L=3000 mm
800 mm L=1500 mm
1000 mm L=1000 mm

bestel de benodigde
koppelplaten apart,
zij worden niet
standaard geleverd
bij de kabelladders

order splice plates
as separate items,
they are not sup-
plied with the
cable ladders

Kabelladder Cable ladder ▶ 300 ◀					Kabelladderdeksel Cable ladder cover	
B	Artikel nr. Product no. L=3000	Gewicht Weight L=3000	Artikel nr. Product no. L=6000	Gewicht Weight L=6000	Artikel nr. Product no.	Gewicht Weight
200	71002.233	13,1	71702.233	26,1	74002.203	10,8
300	71003.233	14,1	71703.233	28,0	74003.203	14,7
400	71004.233	15,1	71704.233	30,3	74004.203	18,6
500	71005.233	16,4	71705.233	32,3	74005.203	22,6
600	71006.233	17,6	71706.233	34,1	74006.203	26,5
800	71008.233	19,7	71708.233	38,5	74008.203	17,1
1000	71010.233	21,9	71710.233	42,4	74010.203	14,1

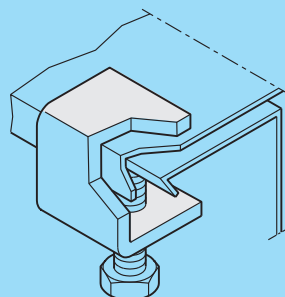
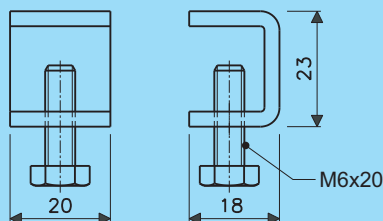

montage-toepassing
mounting application

Dekselsluiting Cover fastener	
Artikel nr. Product no.	Gewicht Weight
66065.203	0,03

bestel de benodigde deksel-
klemmen apart, zij worden
niet geleverd bij de deksels
order cover fasteners as
separate items, they are not
supplied with the covers

Koppelplaat 200/500
Splice plate 200/500

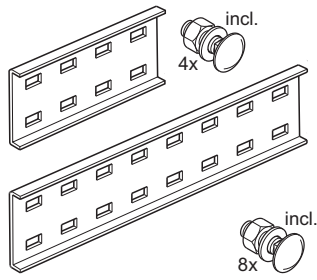

Vert. Scharn. koppelplaat
Vert. hinged splice plate

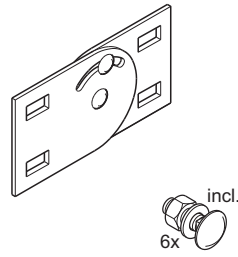

Horiz. scharn. koppelplaat
Horiz. hinged splice plate

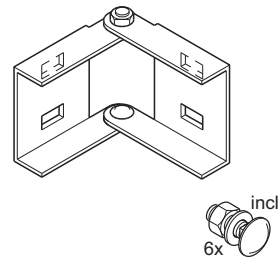

Expansie koppelplaat
Expansion splice plate

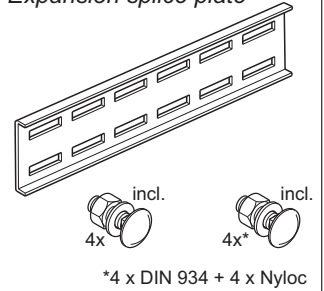

*4 x DIN 934 + 4 x Nyloc

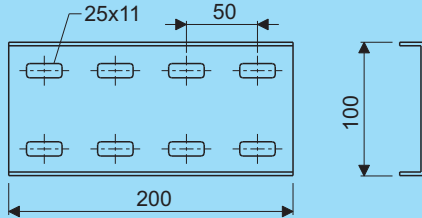

lichte uitvoering, voor toepassing bij overspanningen tot 3 meter

light duty version, for use with spans upto 3 metres

Koppelplaat 200 <i>Splice plate 200</i>	
Artikel nr. <i>Product no.</i>	Gewicht <i>Weight</i>
71024.203	0,42

levering inclusief:
4 slotbouten M10 x 20, moeren en sluitringen
supplied complete with: 4 lock screws M10 x 20, nuts and washers

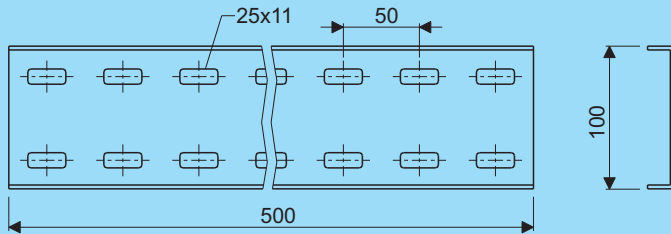

zware uitvoering, voor toepassing bij geconcentreerde belastingen en overspanning tot 4,5 meter

heavy duty version, for use with concentrated loads and spans upto 4.5 metres

Koppelplaat 500 <i>Splice plate 500</i>	
Artikel nr. <i>Product no.</i>	Gewicht <i>Weight</i>
71028.203	0,97

levering inclusief:
8 slotbouten M10 x 20, moeren en sluitringen
supplied complete with: 8 lock screws M10 x 20, nuts and washers

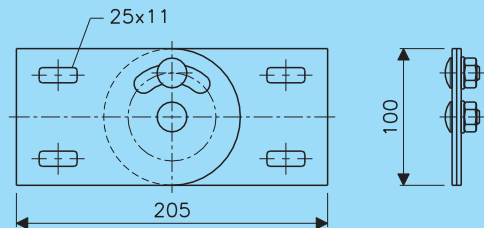

levering inclusief:
6 slotbouten M10 x 20, moeren en sluitringen
supplied complete with: 6 lock screws M10 x 20, nuts and washers

Vert. scharn. koppelplaat <i>Vert. hinged splice plate</i>	
Artikel nr. <i>Product no.</i>	Gewicht <i>Weight</i>
71030.203	0,61

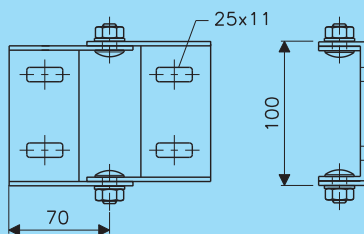

levering inclusief:
6 slotbouten M10 x 20, moeren en sluitringen
supplied complete with: 6 lock screws M10 x 20, nuts and washers

Horiz. scharn. koppelplaat <i>Horiz. hinged splice plate</i>	
Artikel nr. <i>Product no.</i>	Gewicht <i>Weight</i>
71032.203	0,53

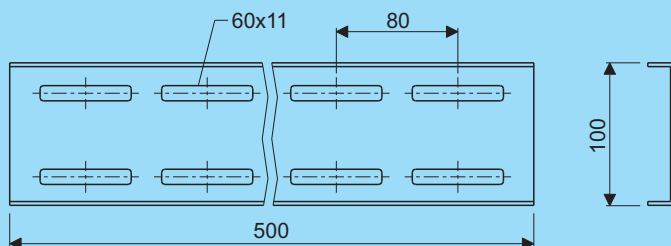

Expansie koppelplaat <i>Expansion splice plate</i>	
Artikel nr. <i>Product no.</i>	Gewicht <i>Weight</i>
71034.203	0,94

levering inclusief:
8 slotbouten M10 x 20, 4 moeren 4 borgmoeren en 8 sluitringen
supplied complete with: 8 lock screws M10 x 20, 4 nuts 4 locking nuts and 8 washers

Crafty MF

H100

Hoekkoppelplaat
Corner splice plate

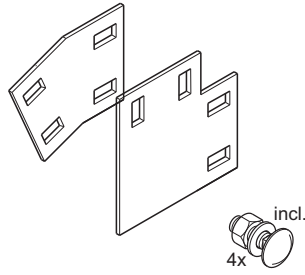

Scheidingsshot H56
Separation strip H56

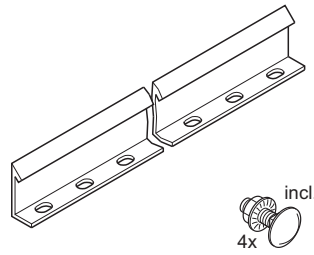

Eindschot
End plate

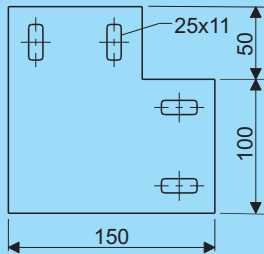
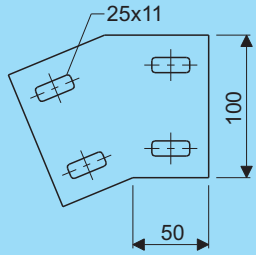
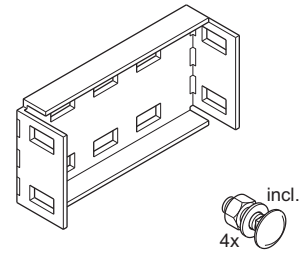

Hoekkoppelplaat
Corner splice plate

\angle	Artikel nr. Product no.	Gewicht Weight
18°	71040.203	0,3
22,5°	71042.203	0,3
30°	71044.203	0,3
45°	71046.203	0,3
90°	71050.203	0,4

levering inclusief:
4 slotbouten M10 x 20,
moeren en sluitringen

supplied complete with:
4 lock screws M10 x 20,
nuts and washers

Crafty MF

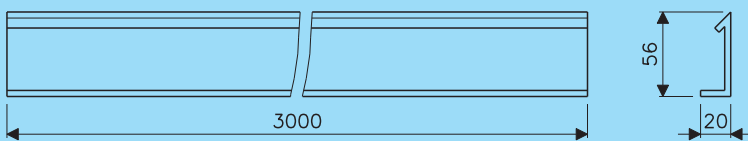
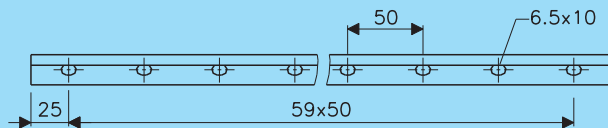

Scheidingsshot H56
Separation strip H56

Artikel nr. Product no.	Gewicht Weight
98743.203	2,2

levering inclusief:
4 slotbouten M6 x 12
en flensmoeren

supplied complete with:
4 lock screws M6 x 12
and flange nuts

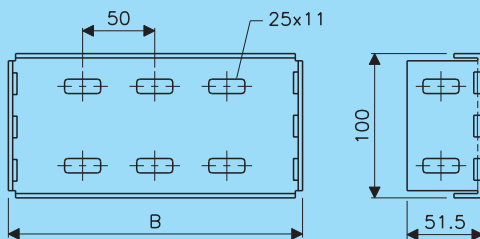

Eindschot
End plate

B	Artikel nr. Product no.	Gewicht Weight
200	71072.203	0,6
300	71073.203	0,7
400	71074.203	0,9
500	71075.203	1,0
600	71076.203	1,2
800	71078.203	1,5
1000	71080.203	2,0

levering inclusief:
4 slotbouten M10 x 20,
moeren en sluitringen

supplied complete with:
4 lock screws M10 x 20,
nuts and washers

Crafty MF

H100

Verloopstuk
Reducer

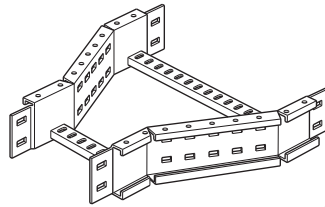

Verloopstuk links of rechts
Reducer left or right

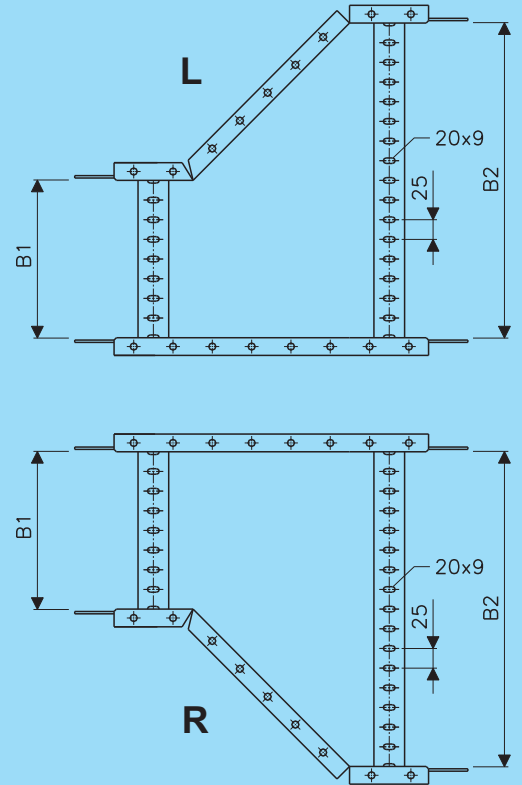
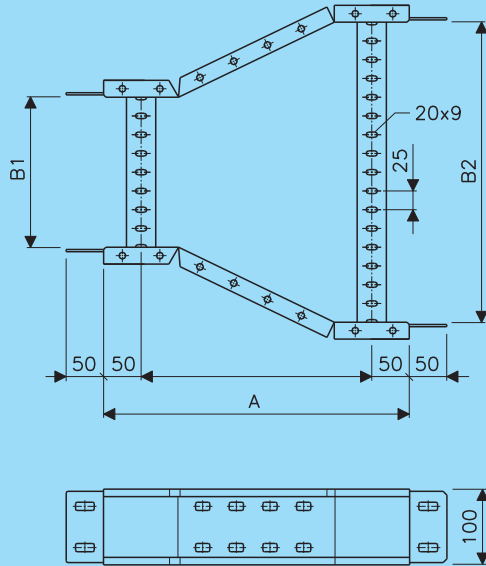
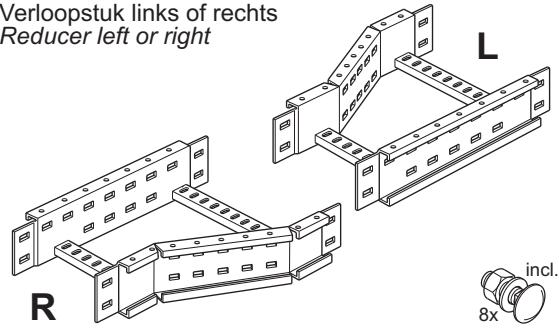

Verloopstuk Reducer				Verloopstukdekseel Reducer cover	
B1 - B2	A	Artikel nr. Product no.	Gewicht Weight	Artikel nr. Product no.	Gewicht Weight
200 - 300	425	71104.233	2,6	74104.203	1,7
200 - 400	408	71105.233	2,7	74105.203	2,0
200 - 500	375	71106.233	2,8	74106.203	2,1
200 - 600	315	71107.233	2,9	74107.203	2,1
300 - 400	425	71108.233	2,8	74108.203	2,2
300 - 500	408	71109.233	2,9	74109.203	2,5
300 - 600	375	71110.233	3,0	74110.203	2,6
400 - 500	425	71111.233	3,0	74111.203	2,8
400 - 600	408	71112.233	3,1	74112.203	3,0
400 - 800	315	71113.233	3,3	74113.203	2,9
500 - 600	425	71114.233	3,2	74114.203	3,3
500 - 800	375	71115.233	3,4	74115.203	3,6
600 - 800	408	71116.233	3,5	74116.203	4,1
600 - 1000	315	71117.233	3,7	74117.203	3,8
800 - 1000	408	71118.233	3,9	74118.203	5,2

levering inclusief:
8 slotbouten M10 x 20,
moeren en sluitringen
*supplied complete with:
8 lock screws M10 x 20,
nuts and washers*

Verloopstuk links Reducer left			Verl. stukdekseel links Reducer cover left	
B1 - B2	Artikel nr. Product no.	Gewicht Weight	Artikel nr. Product no.	Gewicht Weight
200 - 300	71124.233	2,5	74124.203	1,5
200 - 400	71125.233	2,7	74125.203	1,8
200 - 500	71126.233	3,0	74126.203	2,1
200 - 600	71127.233	3,2	74127.203	2,3
300 - 400	71128.233	2,7	74128.203	2,0
300 - 500	71129.233	2,9	74129.203	2,3
300 - 600	71130.233	3,1	74130.203	2,6
400 - 500	71131.233	2,9	74131.203	2,6
400 - 600	71132.233	3,1	74132.203	2,8
400 - 800	71133.233	3,6	74133.203	3,4
500 - 600	71134.233	3,1	74134.203	2,8
500 - 800	71135.233	3,6	74135.203	3,6
600 - 800	71136.233	3,5	74136.203	3,9
600 - 1000	71137.233	4,0	74137.203	4,4
800 - 1000	71138.233	4,0	74138.203	4,9

Verloopstuk rechts Reducer right			Verl. stukdekseel rechts Reducer cover right	
B1 - B2	Artikel nr. Product no.	Gewicht Weight	Artikel nr. Product no.	Gewicht Weight
200 - 300	71144.233	2,5	74144.203	1,5
200 - 400	71145.233	2,7	74145.203	1,8
200 - 500	71146.233	3,0	74146.203	2,1
200 - 600	71147.233	3,2	74147.203	2,3
300 - 400	71148.233	2,7	74148.203	2,0
300 - 500	71149.233	2,9	74149.203	2,3
300 - 600	71150.233	3,1	74150.203	2,6
400 - 500	71151.233	2,9	74151.203	2,6
400 - 600	71152.233	3,1	74152.203	2,8
400 - 800	71153.233	3,6	74153.203	3,4
500 - 600	71154.233	3,1	74154.203	2,8
500 - 800	71155.233	3,6	74155.203	3,6
600 - 800	71156.233	3,5	74156.203	3,9
600 - 1000	71157.233	4,0	74157.203	4,4
800 - 1000	71158.233	4,0	74158.203	4,9

Crafty MF

H100

Horizontaal bochtstuk 45°
Horizontal bend 45°

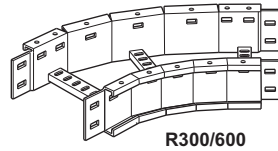

R300/600



incl.

8x

Horizontaal bochtstuk 90°
Horizontal bend 90°

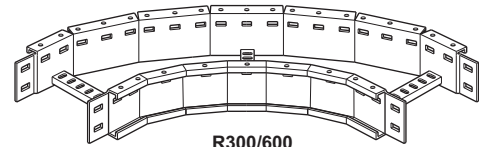

R300/600



8x

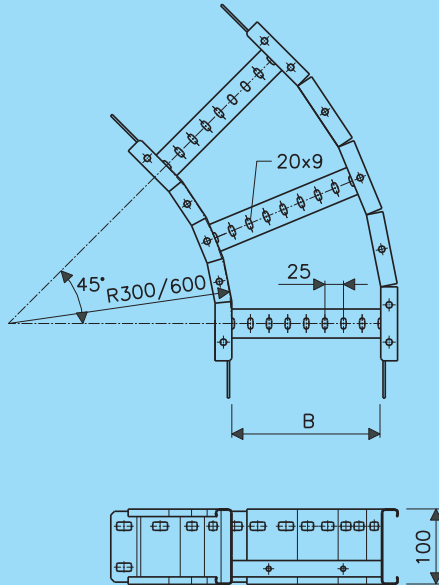

Horizontaal bochtstuk 45° Horizontal bend 45°				
B	Artikel nr. Product no. R=300	Gewicht Weight R=300	Artikel nr. Product no. R=600	Gewicht Weight R=600
200	71162.233	2,6	71162.263	3,6
300	71163.233	3,0	71163.263	4,1
400	71164.233	3,6	71164.263	5,3
500	71165.233	4,0	71165.263	6,0
600	71166.233	4,4	71166.263	6,6
800	71168.233	7,0	71168.263	8,0
1000	71170.233	8,2	71170.263	9,2

Horizontaal bochtstukdeksel 45° Horizontal bend cover 45°				
B	Artikel nr. Product no. R=300	Gewicht Weight R=300	Artikel nr. Product no. R=600	Gewicht Weight R=600
200	74162.203	1,2	74162.263	2,0
300	74163.203	1,9	74163.263	3,0
400	74164.203	2,7	74164.263	4,1
500	74165.203	3,6	74165.263	5,5
600	74166.203	4,6	74166.263	6,8
800	74168.203	6,9	74168.263	9,8
1000	74170.203	9,6	74170.263	13,2

levering inclusief:
8 slotbouten M10 x 20,
moeren en sluitringen

supplied complete with:
8 lock screws M10 x 20,
nuts and washers

ook leverbaar hulpstukken > R=300
technische documentatie op aanvraag
also available fittings > R=300
technical documentation on request

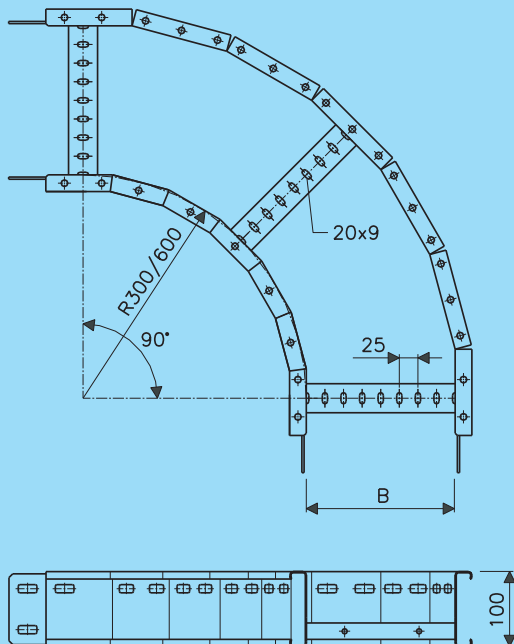

Horizontaal bochtstuk 90° Horizontal bend 90°				
B	Artikel nr. Product no. R=300	Gewicht Weight R=300	Artikel nr. Product no. R=600	Gewicht Weight R=600
200	71182.233	4,0	71182.263	6,1
300	71183.233	4,7	71183.263	6,9
400	71184.233	5,3	71184.263	7,7
500	71185.233	7,6	71185.263	10,5
600	71186.233	7,7	71186.263	11,6
800	71188.233	10,6	71188.263	14,2
1000	71190.233	12,4	71190.263	16,6

Horizontaal bochtstukdeksel 90° Horizontal bend cover 90°				
B	Artikel nr. Product no. R=300	Gewicht Weight R=300	Artikel nr. Product no. R=600	Gewicht Weight R=600
200	74182.203	2,2	74182.263	3,9
300	74183.203	3,5	74183.263	5,9
400	74184.203	5,0	74184.263	8,1
500	74185.203	6,6	74185.263	10,9
600	74186.203	8,5	74186.263	13,6
800	74188.203	13,0	74188.263	19,4
1000	74190.203	18,2	74190.263	26,2

levering inclusief:
8 slotbouten M10 x 20,
moeren en sluitringen

supplied complete with:
8 lock screws M10 x 20,
nuts and washers

ook leverbaar hulpstukken > R=300
technische documentatie op aanvraag
also available fittings > R=300
technical documentation on request

Crafty MF

H100

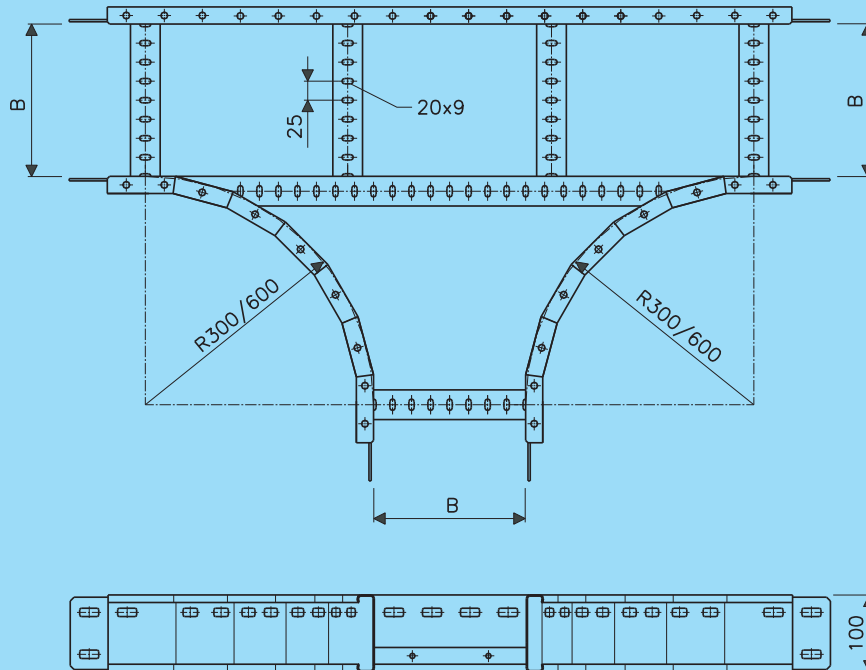
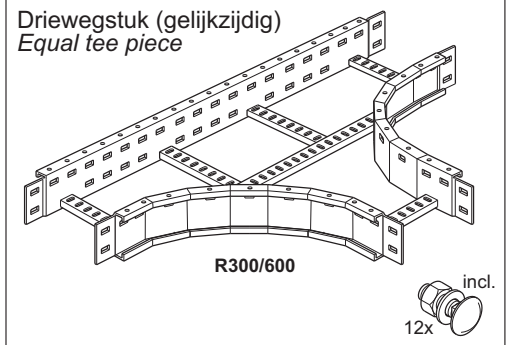

Driewegstuk (gelijkzijdig) Equal tee piece					Driewegstukdeksel (gelijkzijdig) Equal tee piece cover				
B	Artikel nr. Product no. R=300	Gewicht Weight R=300	Artikel nr. Product no. R=600	Gewicht Weight R=600	B	Artikel nr. Product no. R=300	Gewicht Weight R=300	Artikel nr. Product no. R=600	Gewicht Weight R=600
200	71222.233	6,2	71222.263	10,3	200	74222.203	4,2	74222.263	9,6
300	71223.233	7,0	71223.263	11,6	300	74223.203	6,2	74223.263	13,2
400	71224.233	7,8	71224.263	12,7	400	74224.203	8,6	74224.263	16,5
500	71225.233	9,0	71225.263	14,4	500	74225.203	11,1	74225.263	20,2
600	71226.233	10,0	71226.263	15,6	600	74226.203	14,0	74226.263	24,7
800	71228.233	11,8	71228.263	18,9	800	74228.203	19,7	74228.263	33,2
1000	71230.233	14,6	71230.263	21,4	1000	74230.203	27,1	74230.263	43,2

levering inclusief:
12 slotbouten M10 x 20,
moeren en sluitringen

supplied complete
with: 12 lock screws M10 x 20,
nuts and washers

Crafty MF

H100

Vierwegstuk
Cross piece

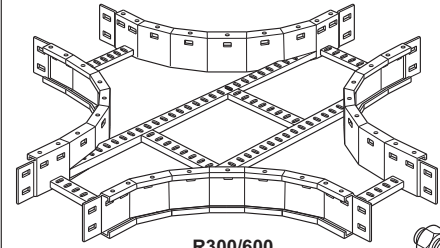

R300/600

incl.
16x

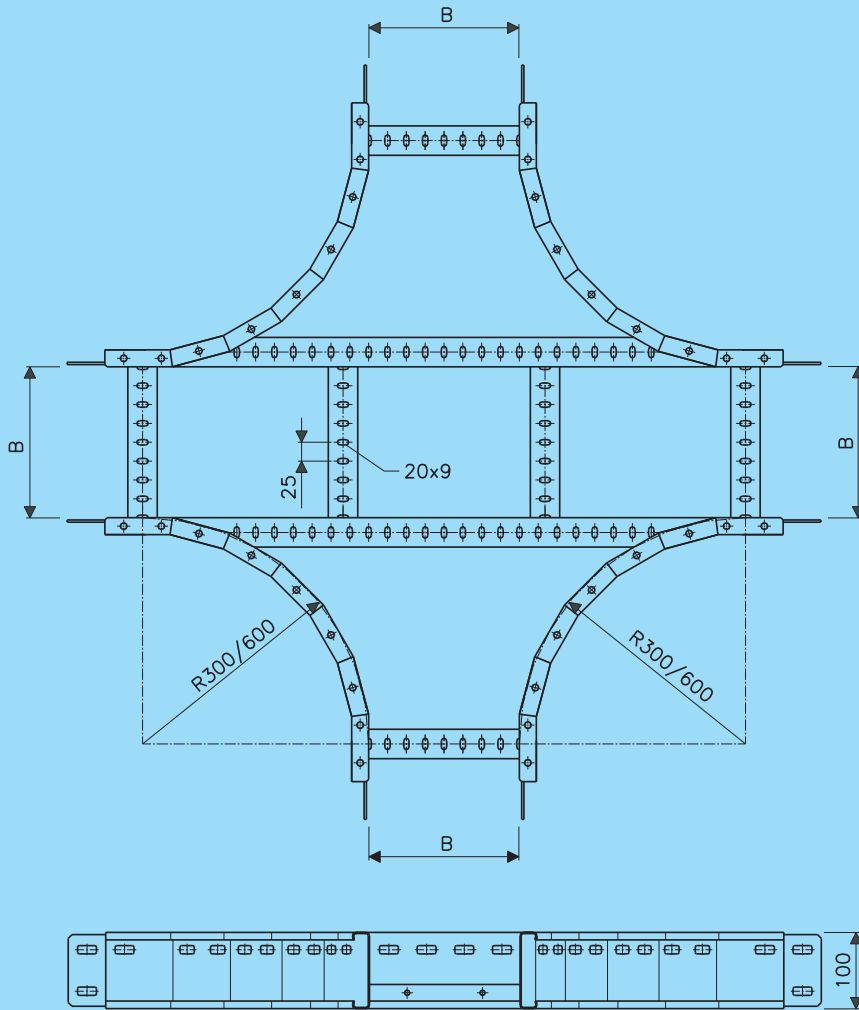

Crafty MF

Vierwegstuk Cross piece								Vierwegstukdeksel Cross piece cover			
B1	B2	B3	B4	Artikel nr. Product no. R=300	Gewicht Weight R=300	Artikel nr. Product no. R=600	Gewicht Weight R=600	Artikel nr. Product no. R=300	Gewicht Weight R=300	Artikel nr. Product no. R=600	Gewicht Weight R=600
200	200	200	200	71302.233	7,8	71302.263	9,3	74302.203	5,6	74302.263	14,2
300	300	300	300	71303.233	8,7	71303.263	10,5	74303.203	8,1	74303.263	18,4
400	400	400	400	71304.233	9,6	71304.263	11,9	74304.203	9,7	74304.263	22,9
500	500	500	500	71305.233	11,0	71305.263	13,6	74305.203	12,6	74305.263	27,6
600	600	600	600	71306.233	11,8	71306.263	14,8	74306.203	15,8	74306.263	32,6
800	800	800	800	71308.233	14,6	71308.263	18,5	74308.203	22,9	74308.263	43,3
1000	1000	1000	1000	71310.233	16,7	71310.263	21,3	74310.203	31,0	74310.263	55,0

levering inclusief:
16 slotbouten M10 x 20,
moeren en sluitringen

supplied complete with:
16 lock screws M10 x 20,
nuts and washers

Crafty MF

H100

Stijgstuk 90°
Vertical inner bend 90°

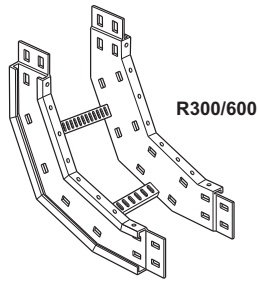

Vervalstuk 90°
Vertical outer bend 90°

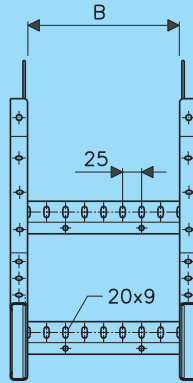
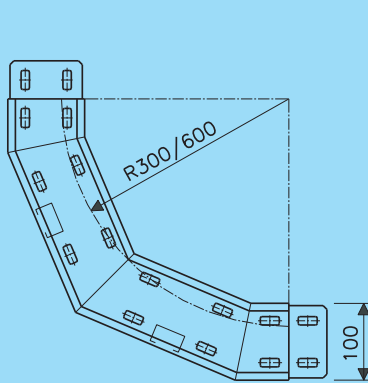
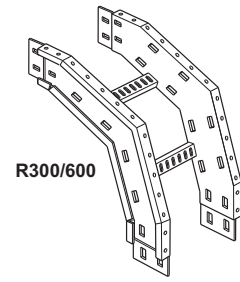

Stijgstuk 90°
Vertical inner bend 90°

B	Artikel nr. Product no. R=300	Gewicht Weight R=300	Artikel nr. Product no. R=600	Gewicht Weight R=600
200	71422.233	2,9	71422.263	4,7
300	71423.233	3,1	71423.263	5,0
400	71424.233	3,3	71424.263	5,3
500	71425.233	3,5	71425.263	5,6
600	71426.233	3,7	71426.263	5,9
800	71428.233	4,1	71428.263	6,5
1000	71430.233	4,5	71430.263	7,1

Stijgstukdeksel 90°
Vertical inner bend cover 90°

B	Artikel nr. Product no. R=300	Gewicht Weight R=300	Artikel nr. Product no. R=600	Gewicht Weight R=600
200	74422.203	1,4	74422.263	2,8
300	74423.203	1,9	74423.263	4,0
400	74424.203	2,5	74424.263	5,2
500	74425.203	3,1	74425.263	6,3
600	74426.203	3,6	74426.263	7,5
800	74428.203	4,8	74428.263	9,9
1000	74430.203	5,9	74430.263	12,2

levering inclusief:
8 slotbouten M10 x 20,
moeren en sluitringen

supplied complete with:
8 lock screws M10 x 20,
nuts and washers

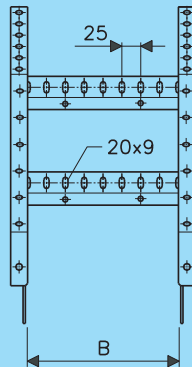
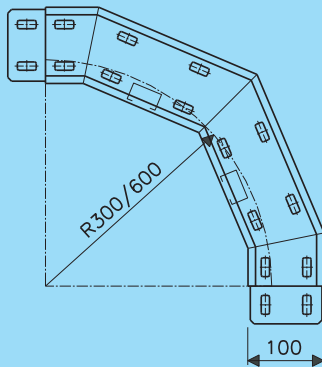

Vervalstuk 90°
Vertical outer bend 90°

B	Artikel nr. Product no. R=300	Gewicht Weight R=300	Artikel nr. Product no. R=600	Gewicht Weight R=600
200	71522.233	2,9	71522.263	4,7
300	71523.233	3,1	71523.263	5,0
400	71524.233	3,3	71524.263	5,3
500	71525.233	3,5	71525.263	5,6
600	71526.233	3,7	71526.263	5,9
800	71528.233	4,1	71528.263	6,5
1000	71530.233	4,5	71530.263	7,1

Vervalstukdeksel 90°
Vertical outer bend cover 90°

B	Artikel nr. Product no. R=300	Gewicht Weight R=300	Artikel nr. Product no. R=600	Gewicht Weight R=600
200	74522.203	1,9	74522.263	3,3
300	74523.203	2,7	74523.263	4,7
400	74524.203	3,4	74524.263	6,1
500	74525.203	4,2	74525.263	7,5
600	74526.203	5,0	74526.263	8,9
800	74528.203	6,6	74528.263	11,6
1000	74530.203	8,2	74530.263	14,4

levering inclusief:
8 slotbouten M10 x 20,
moeren en sluitringen

supplied complete with:
8 lock screws M10 x 20,
nuts and washers

Crafty MF

H150

Kabelladder
Cable ladder

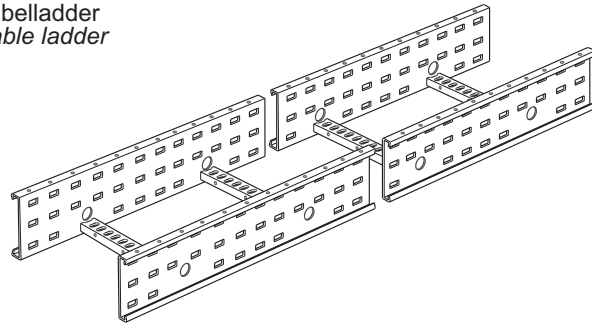

Dekselsluiting
Cover fastener

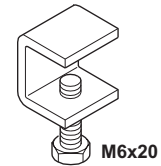

M6x20

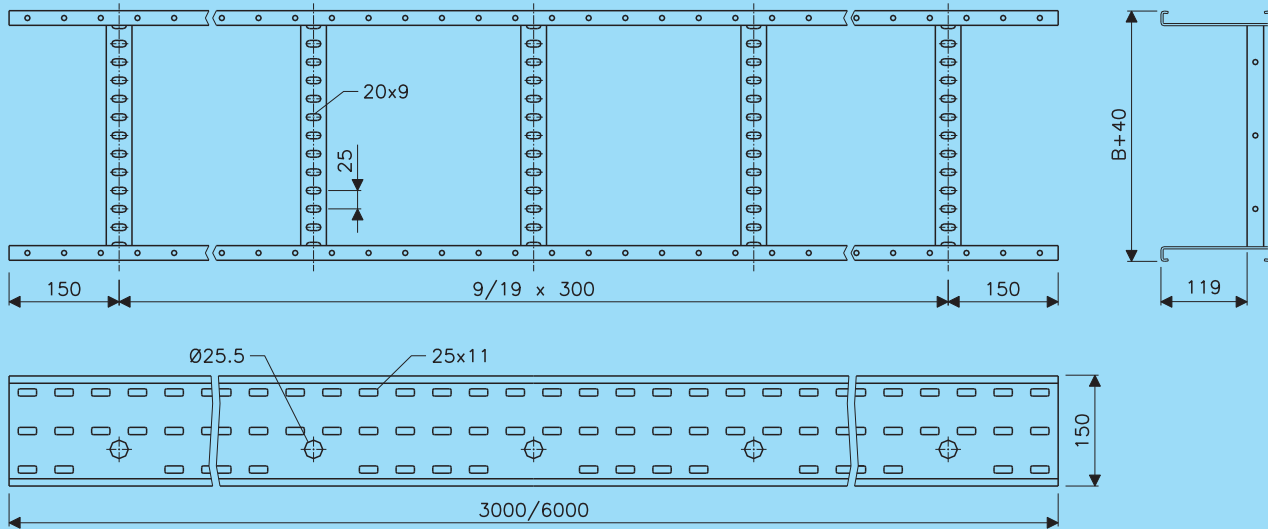

▶ 300 ◀ Hartafstand bodemprofielen
c.t.c. rung distance

kabelladderdeksels:
200 t/m 600 mm L=3000 mm
800 mm L=1500 mm
1000 mm L=1000 mm

cover ladder covers:
200 up to 600 mm L=3000 mm
800 mm L=1500 mm
1000 mm L=1000 mm

bestel de benodigde
koppelplaten apart,
zij worden niet
standaard geleverd
bij de kabelladders

order splice plates
as separate items,
they are not sup-
plied with the
cable ladders

Kabelladder Cable ladder ▶ 300 ◀					Kabelladderdeksel Cable ladder cover	
B	Artikel nr. Product no. L=3000	Gewicht Weight L=3000	Artikel nr. Product no. L=6000	Gewicht Weight L=6000	Artikel nr. Product no.	Gewicht Weight
200	72002.233	20,9	72702.233	42,2	74002.203	10,8
300	72003.233	21,9	72703.233	44,2	74003.203	14,7
400	72004.233	23,0	72704.233	46,4	74004.203	18,6
500	72005.233	24,0	72705.233	48,4	74005.203	22,6
600	72006.233	24,9	72706.233	50,2	74006.203	26,5
800	72008.233	27,1	72708.233	54,0	74008.203	17,1
1000	72010.233	29,0	72710.233	58,5	74010.203	14,1

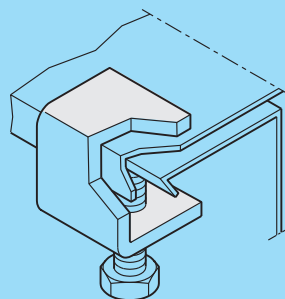
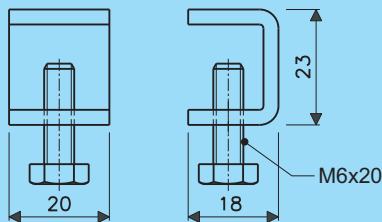

montage toepassing
mounting application

Dekselsluiting Cover fastener	
Artikel nr. Product no.	Gewicht Weight
66065.203	0,03

bestel de benodigde deksel-
klemmen apart, zij worden
niet geleverd bij de deksels
order cover fasteners as
separate items, they are not
supplied with the covers

Koppelplaat 200/500
Splice plate 200/500

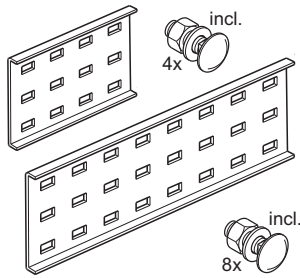

Vert. scharn. koppelplaat
Vert. hinged splice plate

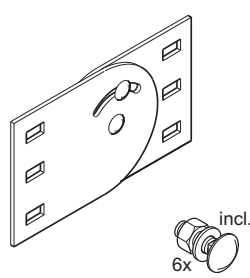

Horiz. scharn. koppelplaat
Horiz. hinged splice plate

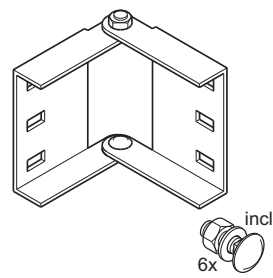

Expansie koppelplaat
Expansion splice plate

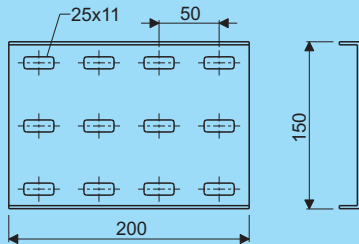
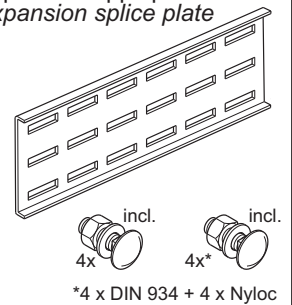

lichte uitvoering, voor toepassing bij overspanningen tot 3 meter

light duty version, for use with spans up to 3 metres

levering inclusief:
4 slotbouten M10 x 20, moeren en sluitringen
supplied complete with:
4 lock screws M10 x 20, nuts and washers

Koppelplaat 200 Splice plate 200	
Artikel nr. Product no.	Gewicht Weight
72024.203	0,64

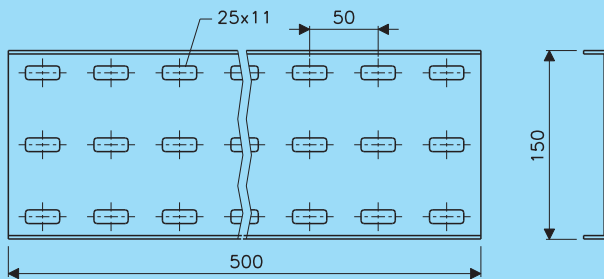

middelzware uitvoering, voor toepassing bij overspanningen tot 6 meter
medium duty version, for use with spans upto 6 metres

Koppelplaat 500 Splice plate 500	
Artikel nr. Product no.	Gewicht Weight
72028.203	1,51

levering inclusief:
8 slotbouten M10 x 20, moeren en sluitringen
supplied complete with:
8 lock screws M10 x 20, nuts and washers

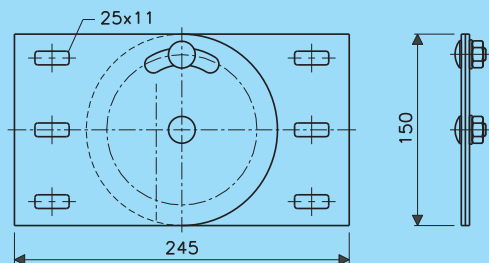

levering inclusief:
6 slotbouten M10 x 20, moeren en sluitringen
supplied complete with:
6 lock screws M10 x 20, nuts and washers

Vert. scharn. koppelplaat Vert. hinged splice plate	
Artikel nr. Product no.	Gewicht Weight
72030.203	1,01

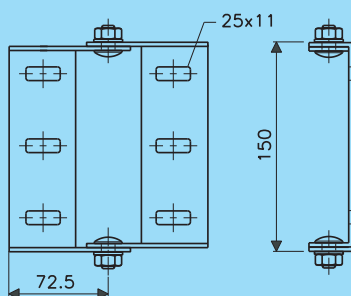

levering inclusief:
6 slotbouten M10 x 20, moeren en sluitringen
supplied complete with:
6 lock screws M10 x 20, nuts and washers

Horiz. scharn. koppelplaat Horiz. hinged splice plate	
Artikel nr. Product no.	Gewicht Weight
72032.203	0,63

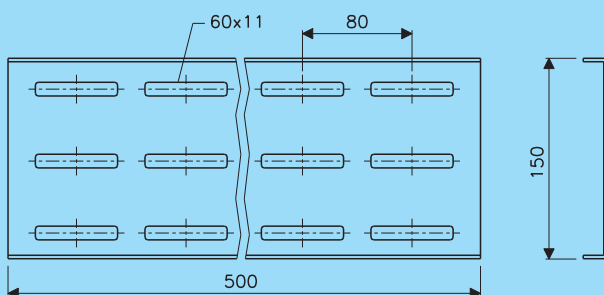

Expansie koppelplaat Expansion splice plate	
Artikel nr. Product no.	Gewicht Weight
72034.203	1,5

levering inclusief:
8 slotbouten M10 x 20, 4 moeren
4 borgmoeren en 8 sluitringen
supplied complete with:
8 lock screws M10 x 20, 4 nuts
4 locking nuts and 8 washers

Crafty MF

H150

Hoekkoppelplaat
Corner splice plate

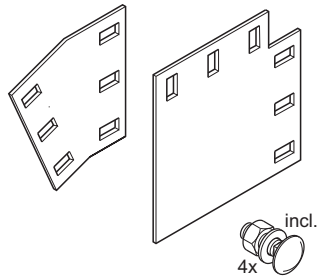

Scheidingsshot H86
Separation strip H86

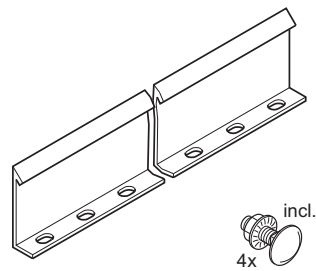

Eindschot
End plate

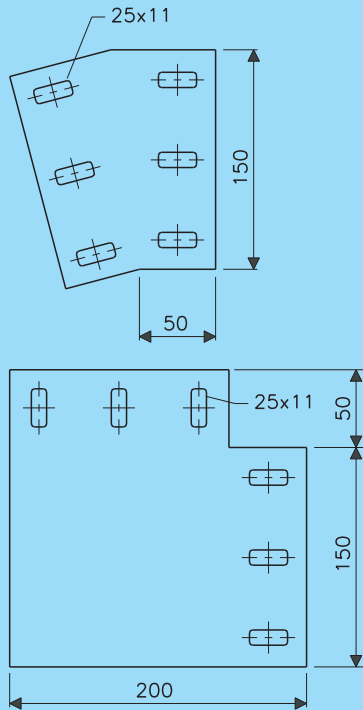
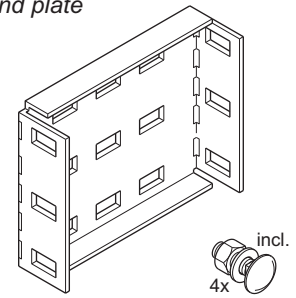

Hoekkoppelplaat
Corner splice plate

\angle	Artikel nr. Product no.	Gewicht Weight
18°	72040.203	0,4
22,5°	72042.203	0,4
30°	72044.203	0,4
45°	72046.203	0,5
90°	72050.203	0,7

levering inclusief:
4 slotbouten M10 x 20,
moeren en sluitringen

supplied complete with:
4 lock screws M10 x 20,
nuts and washers

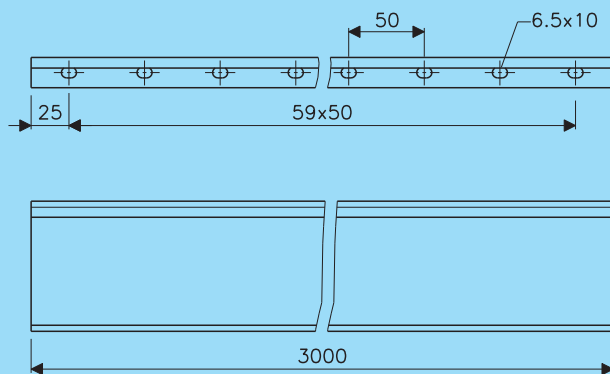

Scheidingsshot H86
Separation strip H86

Artikel nr. Product no.	Gewicht Weight
98749.203	2,9

levering inclusief:
4 slotbouten M6 x 12
en flensmoeren

supplied complete with:
4 lock screws M6 x 12
and flange nuts

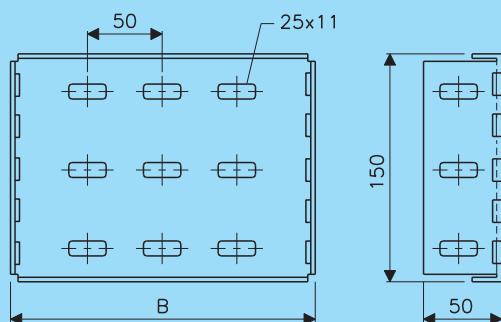

Eindschot
End plate

B	Artikel nr. Product no.	Gewicht Weight
200	72072.203	0,7
300	72073.203	1,0
400	72074.203	1,2
500	72075.203	1,4
600	72076.203	1,6
800	72078.203	2,1
1000	72080.203	2,7

levering inclusief:
4 slotbouten M10 x 20,
moeren en sluitringen

supplied complete with:
4 lock screws M10 x 20,
nuts and washers

Crafty MF

H150

Verloopstuk
Reducer

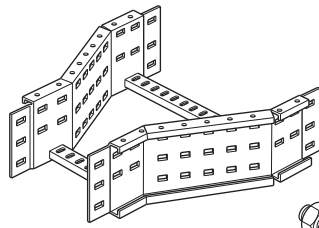

Verloopstuk links of rechts
Reducer left or right

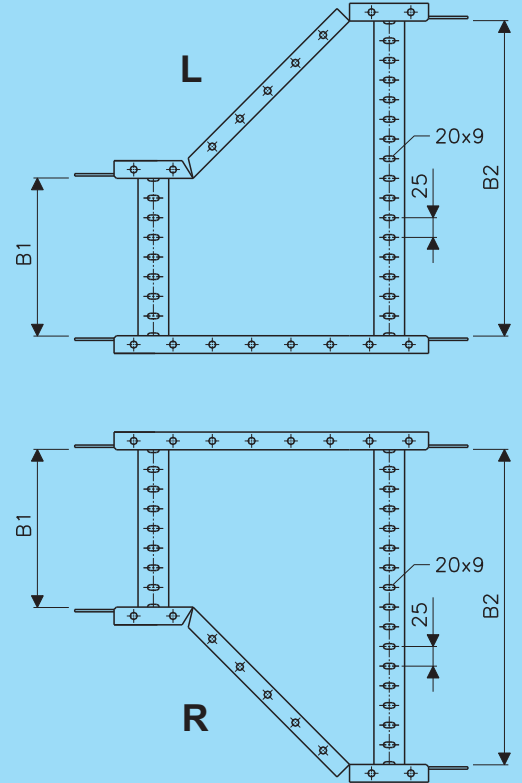
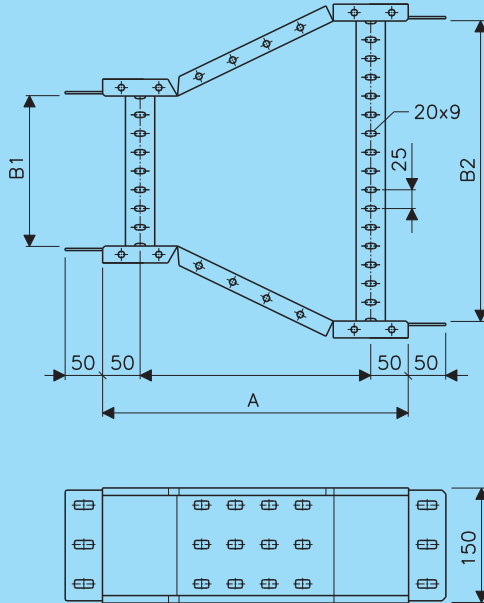
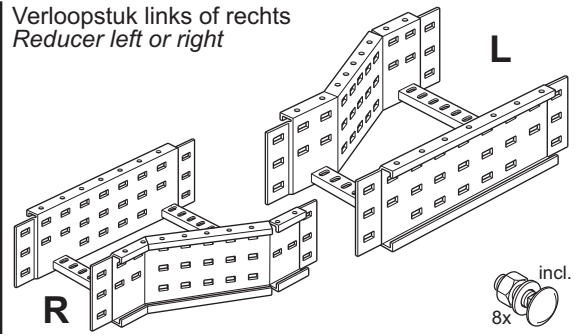

Verloopstuk Reducer				Verloopstukdekseel Reducer cover	
B1 - B2	A	Artikel nr. Product no.	Gewicht Weight	Artikel nr. Product no.	Gewicht Weight
200 - 300	425	72104.233	3,9	74104.203	1,7
200 - 400	408	72105.233	4,1	74105.203	2,0
200 - 500	375	72106.233	4,2	74106.203	2,1
200 - 600	315	72107.233	4,2	74107.203	2,1
300 - 400	425	72108.233	4,2	74108.203	2,2
300 - 500	408	72109.233	4,3	74109.203	2,5
300 - 600	375	72110.233	4,4	74110.203	2,6
400 - 500	425	72111.233	4,4	74111.203	2,8
400 - 600	408	72112.233	4,5	74112.203	3,0
400 - 800	315	72113.233	4,7	74113.203	2,9
500 - 600	425	72114.233	4,6	74114.203	3,3
500 - 800	375	72115.233	4,8	74115.203	3,6
600 - 800	408	72116.233	4,9	74116.203	4,1
600 - 1000	315	72117.233	5,4	74117.203	3,8
800 - 1000	408	72118.233	5,3	74118.203	5,2

levering inclusief:
8 slotbouten M10 x 20,
moeren en sluitringen
*supplied complete with:
8 lock screws M10 x 20,
nuts and washers*

Verloopstuk links Reducer left			Verl. stukdekseel links Reducer cover left	
B1 - B2	Artikel nr. Product no.	Gewicht Weight	Artikel nr. Product no.	Gewicht Weight
200 - 300	72124.233	3,8	74124.203	1,5
200 - 400	72125.233	4,1	74125.203	1,8
200 - 500	72126.233	4,4	74126.203	2,1
200 - 600	72127.233	4,8	74127.203	2,3
300 - 400	72128.233	4,0	74128.203	2,0
300 - 500	72129.233	4,3	74129.203	2,3
300 - 600	72130.233	4,6	74130.203	2,6
400 - 500	72131.233	4,2	74131.203	2,6
400 - 600	72132.233	4,5	74132.203	2,8
400 - 800	72133.233	5,2	74133.203	3,4
500 - 600	72134.233	4,4	74134.203	2,8
500 - 800	72135.233	5,0	74135.203	3,6
600 - 800	72136.233	5,0	74136.203	3,9
600 - 1000	72137.233	5,6	74137.203	4,4
800 - 1000	72138.233	5,3	74138.203	4,9

Verloopstuk rechts Reducer right			Verl. stukdekseel rechts Reducer cover right	
B1 - B2	Artikel nr. Product no.	Gewicht Weight	Artikel nr. Product no.	Gewicht Weight
200 - 300	72144.233	3,8	74144.203	1,5
200 - 400	72145.233	4,1	74145.203	1,8
200 - 500	72146.233	4,4	74146.203	2,1
200 - 600	72147.233	4,8	74147.203	2,3
300 - 400	72148.233	4,0	74148.203	2,0
300 - 500	72149.233	4,3	74149.203	2,3
300 - 600	72150.233	4,6	74150.203	2,6
400 - 500	72151.233	4,2	74151.203	2,6
400 - 600	72152.233	4,5	74152.203	2,8
400 - 800	72153.233	5,2	74153.203	3,4
500 - 600	72154.233	4,4	74154.203	2,8
500 - 800	72155.233	5,0	74155.203	3,6
600 - 800	72156.233	5,0	74156.203	3,9
600 - 1000	72157.233	5,6	74157.203	4,4
800 - 1000	72158.233	5,3	74158.203	4,9

Crafty MF

H150

Horizontaal bochtstuk 45°
Horizontal bend 45°

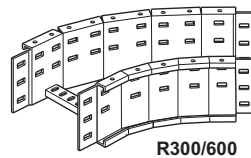

R300/600



incl.

8x

Horizontaal bochtstuk 90°
Horizontal bend 90°

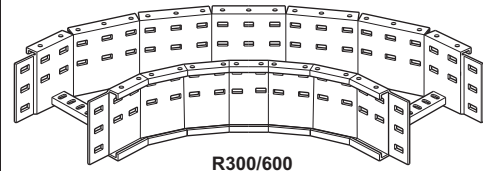

R300/600



incl.

8x

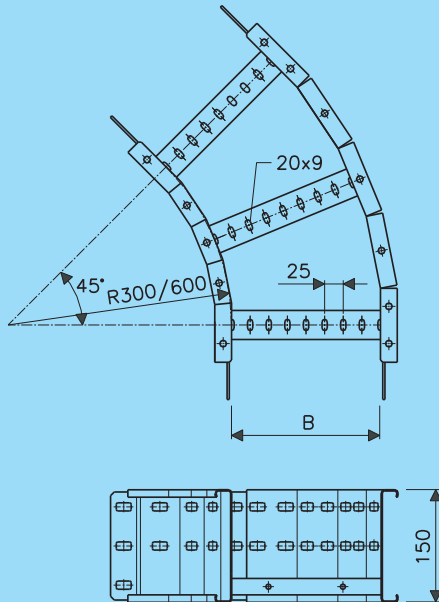

Horizontaal bochtstuk 45° Horizontal bend 45°				
B	Artikel nr. Product no. R=300	Gewicht Weight R=300	Artikel nr. Product no. R=600	Gewicht Weight R=600
200	72162.233	4,0	72162.263	5,6
300	72163.233	4,5	72163.263	6,2
400	72164.233	5,0	72164.263	7,5
500	72165.233	5,6	72165.263	8,3
600	72166.233	6,2	72166.263	8,6
800	72168.233	8,9	72168.263	10,7
1000	72170.233	10,3	72170.263	12,1

Horizontaal bochtstukdeksel 45° Horizontal bend cover 45°				
B	Artikel nr. Product no. R=300	Gewicht Weight R=300	Artikel nr. Product no. R=600	Gewicht Weight R=600
200	74162.203	1,2	74162.263	2,0
300	74163.203	1,9	74163.263	3,0
400	74164.203	2,7	74164.263	4,1
500	74165.203	3,6	74165.263	5,5
600	74166.203	4,6	74166.263	6,8
800	74168.203	6,9	74168.263	9,8
1000	74170.203	9,6	74170.263	13,2

ook leverbaar hulpstukken > R=300
technische documentatie op aanvraag
also available fittings > R=300
technical documentation on request

levering inclusief:
8 slotbouten M10 x 20,
moeren en sluitringen
supplied complete with:
8 lock screws M10 x 20,
nuts and washers

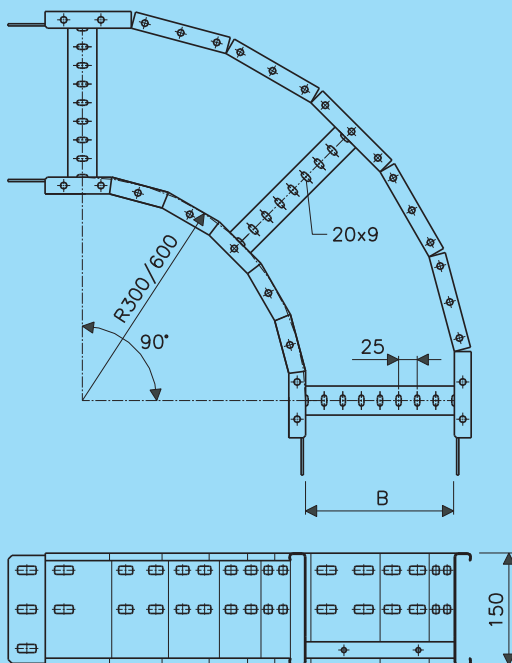

Horizontaal bochtstuk 90° Horizontal bend 90°				
B	Artikel nr. Product no. R=300	Gewicht Weight R=300	Artikel nr. Product no. R=600	Gewicht Weight R=600
200	72182.233	6,2	72182.263	9,6
300	72183.233	7,0	72183.263	10,7
400	72184.233	7,9	72184.263	11,7
500	72185.233	10,2	72185.263	14,7
600	72186.233	11,6	72186.263	15,6
800	72188.233	14,2	72188.263	18,5
1000	72190.233	16,4	72190.263	21,8

Horizontaal bochtstukdeksel 90° Horizontal bend cover 90°				
B	Artikel nr. Product no. R=300	Gewicht Weight R=300	Artikel nr. Product no. R=600	Gewicht Weight R=600
200	74182.203	2,2	74182.263	3,9
300	74183.203	3,5	74183.263	5,9
400	74184.203	5,0	74184.263	8,1
500	74185.203	6,6	74185.263	10,9
600	74186.203	8,5	74186.263	13,6
800	74188.203	13,0	74188.263	19,4
1000	74190.203	18,2	74190.263	26,2

ook leverbaar hulpstukken > R=300
technische documentatie op aanvraag
also available fittings > R=300
technical documentation on request

levering inclusief:
8 slotbouten M10 x 20,
moeren en sluitringen
supplied complete with:
8 lock screws M10 x 20,
nuts and washers

Crafty MF

H150

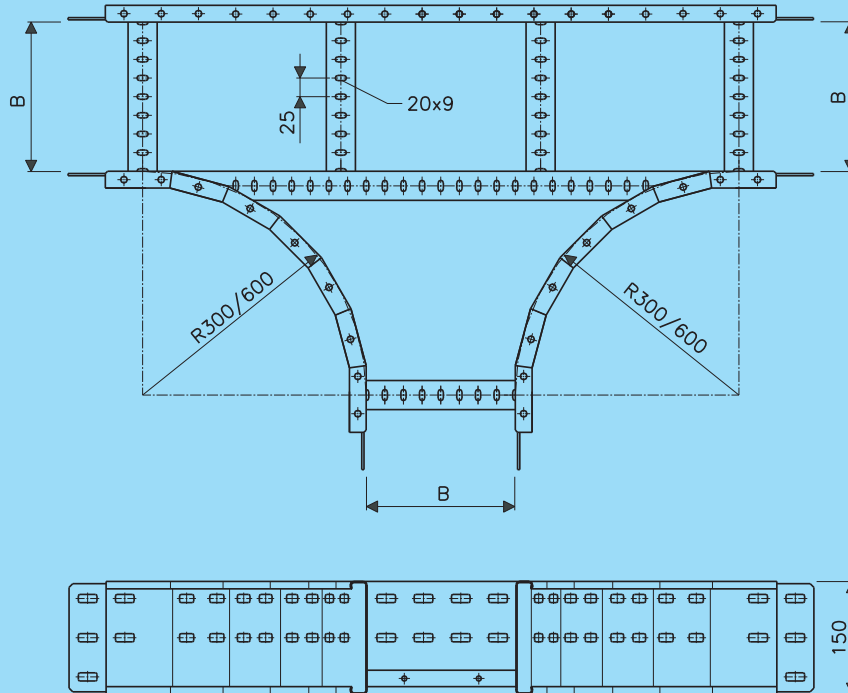
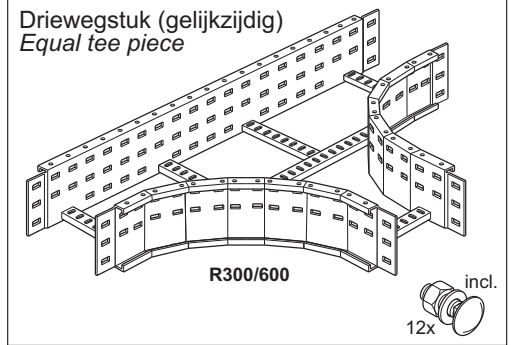

Driewegstuk (gelijkzijdig) Equal tee piece					Driewegstukdeksel (gelijkzijdig) Equal tee piece cover				
B	Artikel nr. Product no. R=300	Gewicht Weight R=300	Artikel nr. Product no. R=600	Gewicht Weight R=600	B	Artikel nr. Product no. R=300	Gewicht Weight R=300	Artikel nr. Product no. R=600	Gewicht Weight R=600
200	72222.233	9,3	72222.263	15,7	200	74222.203	4,2	74222.263	9,6
300	72223.233	10,2	72223.263	17,0	300	74223.203	6,2	74223.263	13,2
400	72224.233	11,2	72224.263	18,3	400	74224.203	8,6	74224.263	16,5
500	72225.233	12,6	72225.263	20,0	500	74225.203	11,1	74225.263	20,2
600	72226.233	13,5	72226.263	21,3	600	74226.203	14,0	74226.263	24,7
800	72228.233	16,4	72228.263	25,0	800	74228.203	19,7	74228.263	33,2
1000	72230.233	18,6	72230.263	27,8	1000	74230.203	27,1	74230.263	43,2

levering inclusief:
12 slotbouten M10 x 20,
moeren en sluitringen

supplied complete
with: 12 lock screws M10 x 20,
nuts and washers

Crafty MF

H150

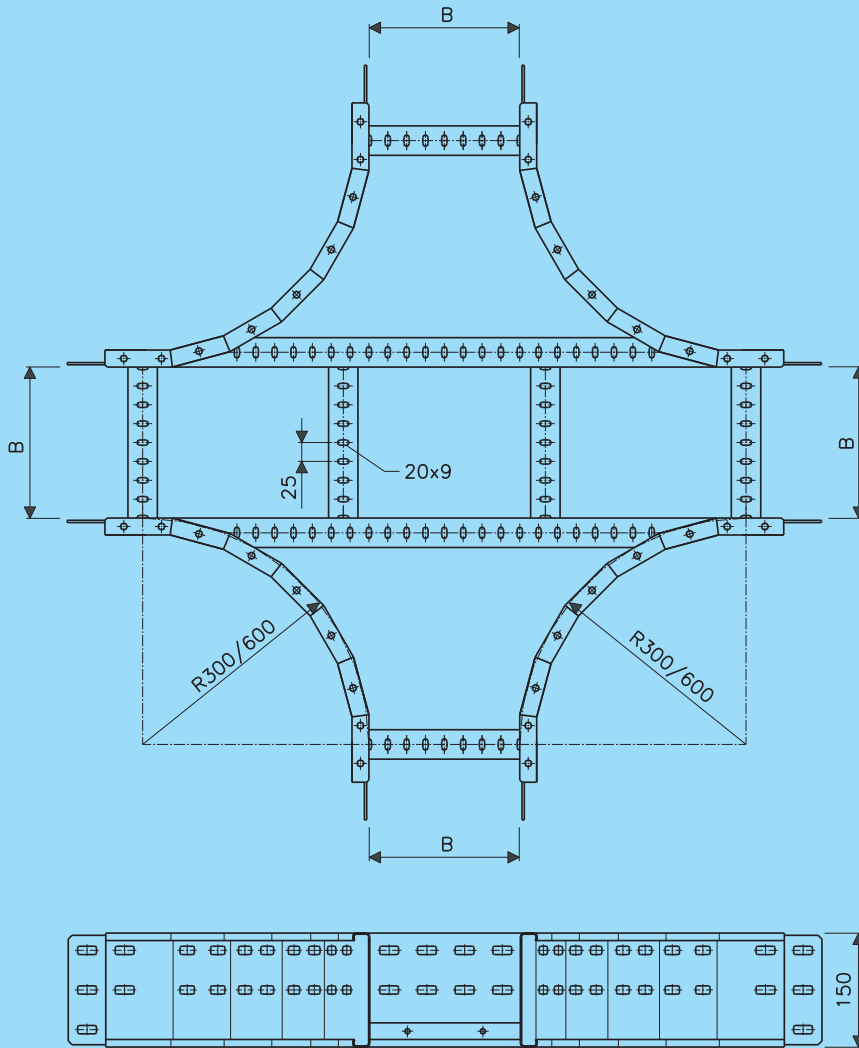
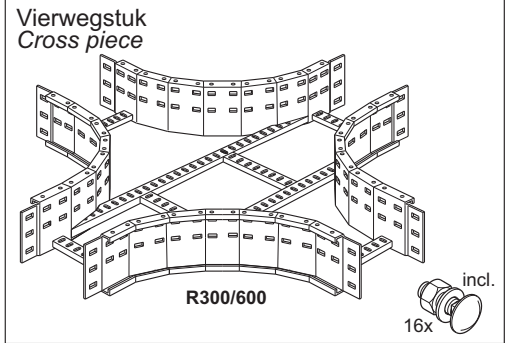

Crafty MF

Vierwegstuk Cross piece								Vierwegstukdeksel Cross piece cover			
B1	B2	B3	B4	Artikel nr. Product no. R=300	Gewicht Weight R=300	Artikel nr. Product no. R=600	Gewicht Weight R=600	Artikel nr. Product no. R=300	Gewicht Weight R=300	Artikel nr. Product no. R=600	Gewicht Weight R=600
200	200	200	200	72302.233	11,3	72302.263	19,8	74302.203	5,6	74302.263	14,2
300	300	300	300	72303.233	12,1	72303.263	21,1	74303.203	8,1	74303.263	18,4
400	400	400	400	72304.233	13,0	72304.263	22,4	74304.203	9,7	74304.263	22,9
500	500	500	500	72305.233	14,3	72305.263	24,1	74305.203	12,6	74305.263	27,6
600	600	600	600	72306.233	15,2	72306.263	25,4	74306.203	15,8	74306.263	32,6
800	800	800	800	72308.233	18,1	72308.263	28,9	74308.203	22,9	74308.263	43,3
1000	1000	1000	1000	72310.233	20,1	72310.263	31,9	74310.203	31,0	74310.263	55,0

levering inclusief:
16 slotbouten M10 x 20,
moeren en sluitringen

supplied complete with:
16 lock screws M10 x 20,
nuts and washers

Crafty MF

H150

Stijgstuk 90°
Vertical inner bend 90°

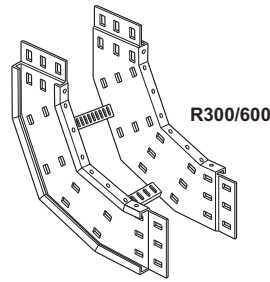

Vervalstuk 90°
Vertical outer bend 90°

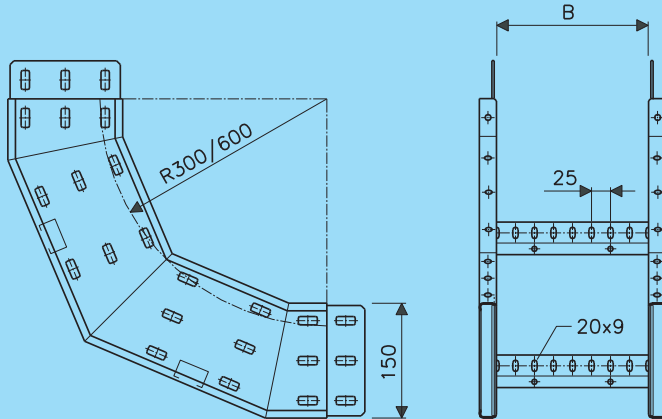
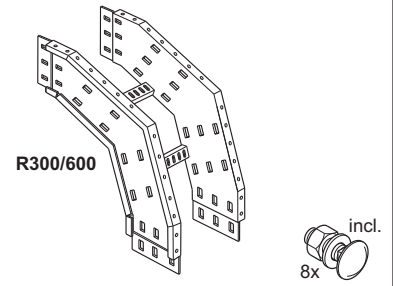

Stijgstuk 90° Vertical inner bend 90°				
B	Artikel nr. Product no. R=300	Gewicht Weight R=300	Artikel nr. Product no. R=600	Gewicht Weight R=600
200	72422.233	4,7	72422.263	7,9
300	72423.233	5,0	72423.263	8,2
400	72424.233	5,2	72424.263	8,5
500	72425.233	5,4	72425.263	8,8
600	72426.233	5,5	72426.263	9,2
800	72428.233	6,0	72428.263	9,7
1000	72430.233	6,4	72430.263	10,3

Stijgstukdekseel 90° Vertical inner bend cover 90°				
B	Artikel nr. Product no. R=300	Gewicht Weight R=300	Artikel nr. Product no. R=600	Gewicht Weight R=600
200	74422.203	1,4	74422.263	2,8
300	74423.203	1,9	74423.263	4,0
400	74424.203	2,5	74424.263	5,2
500	74425.203	3,1	74425.263	6,3
600	74426.203	3,6	74426.263	7,5
800	74428.203	4,8	74428.263	9,9
1000	74430.203	5,9	74430.263	12,2

levering inclusief:
8 slotbouten M10 x 20,
moeren en sluitringen
*supplied complete with:
8 lock screws M10 x 20,
nuts and washers*

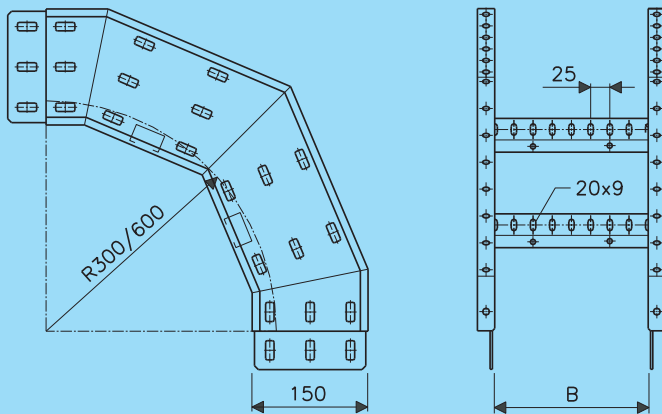

Vervalstuk 90° Vertical outer bend 90°				
B	Artikel nr. Product no. R=300	Gewicht Weight R=300	Artikel nr. Product no. R=600	Gewicht Weight R=600
200	72622.233	4,7	72622.263	7,9
300	72623.233	5,0	72623.263	8,2
400	72624.233	5,2	72624.263	8,5
500	72625.233	5,4	72625.263	8,8
600	72626.233	5,5	72626.263	9,2
800	72628.233	6,0	72628.263	9,7
1000	72630.233	6,4	72630.263	10,3

Vervalstukdekseel 90° Vertical outer bend cover 90°				
B	Artikel nr. Product no. R=300	Gewicht Weight R=300	Artikel nr. Product no. R=600	Gewicht Weight R=600
200	74622.203	2,1	74622.263	3,6
300	74623.203	3,0	74623.263	5,1
400	74624.203	4,0	74624.263	6,6
500	74625.203	4,8	74625.263	8,0
600	74626.203	5,7	74626.263	9,5
800	74628.203	7,5	74628.263	12,5
1000	74630.203	9,3	74630.263	15,5

levering inclusief:
8 slotbouten M10 x 20,
moeren en sluitringen
*supplied complete with:
8 lock screws M10 x 20,
nuts and washers*

Notities

Notes

Dotted lines for writing.

Crafty MF

Notities

Notes

A series of horizontal dotted lines for writing notes.



GoudaHolland B.V.

P.O. Box 8
2850AA Haastrecht
The Netherlands

tel. +31 (0) 182-506200
fax. +31 (0) 182-506209

www.goudaholland.nl
info@goudaholland.nl



GoudaHolland

